



U.S. National Library of Medicine
National Center for Biotechnology Information

NLM Citation: Adam MP, Feldman J, Mirzaa GM, et al., editors. GeneReviews® [Internet]. Seattle (WA): University of Washington, Seattle; 1993-2024. GeneReviews Glossary.
Bookshelf URL: <https://www.ncbi.nlm.nih.gov/books/>



GeneReviews Glossary

Terms and Definitions

allele

One version of a gene at a given location (locus) along a chromosome

Related terms: allele frequency; benign variant; compound heterozygous; heterozygote; homozygous; likely benign; likely pathogenic; locus; pathogenic variant; polymorphism; variant of uncertain significance; wild type

allele frequency

The proportion of individuals in a population who have inherited a specific variant

allelic heterogeneity

Synonym: molecular heterogeneity

Presence of different pathogenic variants in the same gene and at the same chromosome locus that cause a single disease phenotype

Related term: allele

alternate maternity

Synonym: non-maternity

The situation in which the presumed mother of a particular individual is not the biological mother

Related term: misattributed parentage

alternate paternity

Synonym: non-paternity

The situation in which the presumed father of a particular individual is not the biological father

Related term: misattributed parentage

analyte

A chemical substance of interest; a biologic component whose properties (e.g., concentration, presence, absence) can be indicators of human disease; in inherited conditions properties of analytes of interest are often measured in a biochemical/metabolic specialty laboratory to identify abnormalities in a metabolic pathway.

aneuploidy

The occurrence of one or more extra or missing chromosomes leading to an unbalanced chromosome complement, or any chromosome number that is not an exact multiple of the haploid number

anticipation

The tendency in certain genetic disorders for individuals in successive generations to present at an earlier age and/or with more severe manifestations; often observed in disorders resulting from the expression of a nucleotide repeat expansion that tends to increase in size and have a more significant effect when passed from one generation to the next

Related terms: intrafamilial variability; nucleotide repeat; trinucleotide repeat; variable expressivity

Ashkenazi Jewish

Synonym: Eastern European Jewish

The Eastern European Jewish population primarily from Germany, Poland, and Russia, in contrast to the Sephardic Jewish population primarily from Spain, parts of France, Italy, and North Africa

autosomal

Referring to any of the chromosomes other than the sex-determining chromosomes (i.e., the X and Y) or to the genes on these chromosomes

autosomal dominant

Referring to a trait or disorder in which the phenotype can be expressed in individuals who have one copy of a pathogenic variant at a particular locus (heterozygotes); specifically refers to a gene on one of the 22 pairs of autosomes (non-sex chromosomes)

Related terms: *de novo*; germline mosaicism; heterozygote; mode of inheritance; penetrance; variable expressivity

autosomal recessive

Referring to a trait or disorder requiring the presence of biallelic pathogenic variants (i.e., homozygous or compound heterozygous variants) at a particular locus in order to express an observable phenotype; specifically refers to genes on one of the 22 pairs of autosomes (non-sex chromosomes)

Related terms: allele frequency; carrier; carrier testing; compound heterozygous; consanguineous; heterozygote; homozygous; mode of inheritance

background risk

The proportion of individuals in a given population who are affected with a particular disorder or who have pathogenic variants in a certain gene; often discussed in the genetic counseling process as a comparison to the proband's personal risk given his/her family history or other circumstances

Related terms: allele frequency; carrier rate

base pair

Synonym: bp

Two nitrogenous bases paired together in double-stranded DNA by weak bonds; specific pairing of these bases (adenine with thymine and guanine with cytosine) facilitates accurate DNA replication; when quantified (e.g., 8 bp), refers to the physical length of a sequence of nucleotides

benign variant

Synonym: polymorphism

An alteration in DNA (distinct from the reference sequence) that is not associated with an abnormal phenotype or increased disease risk. A benign variant meets criteria to be classified as benign according to the five-tier system of describing the clinical significance of genetic variants (See related terms).

Related terms: likely benign; likely pathogenic; pathogenic variant; variant of uncertain significance

biallelic

Referring to both alleles of a gene pair. Biallelic variants may be homozygous or compound heterozygous.

Related terms: compound heterozygous; homozygous; *trans*

carrier

An individual with a recessive pathogenic variant at a particular locus on one chromosome of a pair who is not expected to develop manifestations of the related condition; may also refer to an individual with a balanced chromosome rearrangement. Note regarding autosomal dominant disorders: While the terms "heterozygote" and "carrier" are often used synonymously in the literature, *GeneReviews* does not consider a heterozygote (who has - or is at risk of developing - manifestations of a disorder) to be a carrier.

Related terms: autosomal recessive; carrier rate; carrier testing; heterozygote; obligate heterozygote; X-linked

carrier rate

Synonym: carrier frequency

The proportion of individuals in a population who have a single copy of a recessive variant that is pathogenic for a specific condition

Related terms: allele frequency; carrier; heterozygote

carrier testing

Synonym: carrier detection

Testing used in the course of reproductive counseling to identify (typically) asymptomatic individuals who are heterozygous for a pathogenic variant associated with a specific autosomal recessive or X-linked disorder

Related terms: autosomal recessive; carrier; heterozygote; molecular genetic testing; pathogenic variant; X-linked

cDNA

Complementary DNA; the reverse-transcribed mRNA. The cDNA sequence of a gene differs from the genomic sequence of the gene in that it does not include the introns; cDNA does not occur in nature but can be synthesized from mRNA using a series of chemical reactions and may be analyzed to determine mRNA

sequence. The nomenclature system used to annotate sequence variants in the context of the coding sequence is based on complementary DNA.

Related terms: gDNA; mRNA

chromosomal microarray

Synonym: CMA

Term that refers to methods used to detect copy number variants (losses or gains of chromosome material), which may be benign, pathogenic, or of uncertain clinical significance. A far more sensitive method than traditional karyotyping, CMA detects both large and small copy number variants. Depending on the method used, CMA may involve scanning of the whole genome (also referred to as cytogenomic CMA), targeted regions of the genome, or a specific chromosome or chromosome segment. The CMA methods used most commonly in clinical practice include oligo (oligonucleotide) array, SNP (single-nucleotide polymorphism) array, and oligo/SNP combination array.

Related terms: comparative genomic hybridization; copy number variant; SNP array

chromosome

Physical structure consisting of a large DNA molecule organized into genes and supported by proteins called chromatin

Related terms: aneuploidy; autosomal; cytogenetic; karyotype

chromosome breakage studies

Cytogenetic testing to detect an increased rate of chromosome breakage or rearrangement in metaphase cells by exposing cell cultures to clastogenic agents such as diepoxybutane (DEB) or mitomycin C (MMC); cell cultures not exposed to the DNA clastogenic agent are used as controls to measure the spontaneous rate of chromosome breakage or rearrangement.

cis

Synonyms: *cis* configuration, coupling

Referring to two variants on the same chromosome (typically used to describe variants within the same gene)

Related term: *trans*

coding region

Synonyms: open reading frame, ORF

DNA sequence that has the potential to be transcribed into RNA and translated into protein; must include a start codon and termination codon

Related terms: exome sequencing; exon; intron; promoter region

codominant

Referring to two phenotypes being expressed at the same time from the same gene; for example, the AB blood groups in humans

comparative genomic hybridization

Method in which two DNA samples (a control and a test sample), labeled in different fluorescent colors, are hybridized to a single target to assay for relative losses (deletions) or gains (duplications) in the DNA of the test sample compared to the control

Related terms: chromosomal microarray; SNP array

compound heterozygous

Referring to two heterozygous variants present in *trans* configuration within the same genomic region of interest (typically within the same gene)

Related terms: biallelic; heterozygote; *trans*

congenital

Present at birth; not necessarily genetic

consanguineous

Referring to reproductive partners who have a relatively close genetic relationship (e.g., cousins)

Related terms: autosomal recessive; pedigree

consanguinity

See consanguineous.

Related terms: autosomal recessive; pedigree

constitutional variant

A variant that is present in all somatic and germline cells and thus has the potential to be passed to subsequent generations; may be used synonymously with "germline variant"

Related term: germline variant

contiguous gene deletion

Deletion of a chromosome segment that encompasses two or more adjacent genes

Related terms: deletion; deletion syndrome

contiguous gene deletion syndrome

A constellation of clinical findings caused by deletion of a chromosome segment that encompasses two or more adjacent genes

Related terms: deletion syndrome; FISH

copy number variant

Synonym: CNV

Duplication or deletion of a section of DNA. CNVs can be benign (normal), pathogenic, or of uncertain clinical significance. The method used to detect a CNV varies based on its size (see deletion/duplication analysis).

Related term: single-nucleotide variant

critical region

The specific portion of a chromosome or a gene that, when altered in some way (deleted, duplicated, or otherwise mutated), produces the characteristic set of phenotypic abnormalities associated with a particular syndrome or disorder

custom prenatal testing

Prenatal testing offered to families in which (a) pathogenic variant(s) have been identified in an affected family member in either a research or clinical laboratory; testing is not otherwise clinically available for prenatal diagnosis.

custom testing

Testing offered to families in which (a) pathogenic variant(s) have been identified in an affected family member in either a research or clinical laboratory; testing is not otherwise clinically available.

cytogenetic

Referring to chromosome abnormalities such as aneuploidies, deletions, duplications, and translocations

Related terms: chromosome; contiguous gene deletion; deletion; deletion syndrome; duplication; FISH; karyotype

de novo

Referring to a genetic variant that is present for the first time in one family member

deletion

Absence of a segment of DNA; may be as small as a single base or as large as one or more genes. The method used to detect a deletion depends on the size of the deletion.

Related term: deletion/duplication analysis

deletion/duplication analysis

Synonym: copy number analysis

Testing that identifies deletions/duplications not routinely detectable by sequence analysis of the coding and flanking intronic regions of genomic DNA; included in the variety of methods that may be used are: quantitative PCR, multiplex ligation-dependent probe amplification (MLPA), and chromosomal microarray (CMA) that includes the gene/chromosome segment of interest.

Related terms: chromosomal microarray; deletion; duplication; FISH; next-generation sequencing; PCR; Sanger sequencing; targeted analysis for pathogenic variants

deletion syndrome

Synonym: microdeletion syndrome

A recognizable phenotype caused by a chromosome deletion that spans one or more genes and may be too small to be detected using conventional cytogenetic methods; the deletion is typically detected by chromosomal microarray (CMA). Depending on the size of the deletion, other techniques including FISH and quantitative PCR can sometimes be employed to identify the deletion.

Related terms: chromosomal microarray (CMA); chromosome; contiguous gene deletion syndrome; FISH; quantitative PCR

digenic

Referring to expression of a phenotype that requires the presence of pathogenic variants in two different genes

Related terms: oligogenic; trigenic

domain

A specific region or amino acid sequence in a protein associated with a particular function or corresponding segment of DNA

dominant-negative

Referring to a single, heterozygous pathogenic variant which produces a protein that interferes with (i.e., dimerizes or combines with, or blocks) the normal protein produced by the other allele, adversely affecting protein function. In cases of polymeric molecules, such as collagen, dominant-negative variants are often more deleterious than variants resulting in no gene product (null variants).

double heterozygosity

The presence in an individual of a heterozygous variant in two different genomic regions of interest (typically, a heterozygous variant in each of two different genes). The clinical consequences of double heterozygosity depend on the related disorder(s) and the mode(s) of inheritance of the disorder(s).

Related term: heterozygote

duplication

The presence of one or more additional copies of a segment of DNA; may be as small as a single base or as large as one or more genes. The method used to detect a duplication depends on the size of the duplication.

Related term: deletion/duplication analysis

dysmorphic

Referring to visible morphologic findings that differ from those commonly seen in the general population or that are expected from the family background

epigenetic

Referring to chemical alterations to DNA nucleotides or proteins that control gene expression but do not alter the DNA sequence

epimutation

A heritable change in gene activity that is not associated with a DNA variant but rather with gain or loss of DNA methylation or other heritable modifications of chromatin

(Reprinted from *Trends in Genetics*, 30:519-20. Oey H, Whitelaw E. On the meaning of the word "epimutation." Copyright 2014, with permission from Elsevier.)

exome

The part of the genome that includes all coding nuclear DNA sequences. The human exome comprises approximately 180,000 exons that are transcribed into mature RNA.

Related terms: coding region; exome sequencing; exon; genome sequencing; next-generation sequencing

exome array

A microarray designed to determine exon-level copy number for as many genes associated with disease as possible regardless of phenotype or clinical features associated with the genes

Related term: gene-targeted array

exome sequencing

Sequence analysis of the exons of protein-coding genes in the genome typically performed by target enrichment or capture of exons followed by next-generation sequencing (NGS). Exome sequencing techniques have nonstandardized, highly variable coverage; of particular note are regions of the exome refractory to accurate sequencing by this method (including genes with a pseudogene, highly repetitive coding regions, and large deletions and duplications). Laboratories may also include sequence analysis of some noncoding regions of the genome (e.g., promoters, highly conserved regulatory sequences). Note that the term "exome sequencing" is preferred over the formerly used term "whole-exome sequencing" because coverage of the exome is less than 100%, and thus the "whole" exome is not sequenced.

Related terms: coding region; exome; exon; genome sequencing; next-generation sequencing

exon

Coding sequence of DNA present in mature messenger RNA

Related terms: coding region; exome sequencing; intron

familial

Referring to a condition or variant that occurs in more than one family member

first-degree relative

A parent, full sib, or child of an individual

Related terms: pedigree; second-degree relative

FISH

Fluorescent in situ hybridization; a technique used to identify the presence of specific chromosomes or chromosomal regions through hybridization (attachment) of fluorescently labeled DNA probes to denatured chromosomal DNA. Examination under fluorescent lighting detects the presence of the hybridized fluorescent signal (and hence presence of the chromosome material) or absence of the hybridized fluorescent signal (and hence absence of the chromosome material).

With **interphase FISH**, probes are introduced directly to the interphase cell. Interphase FISH is often used for rapid detection of specific types of aneuploidy in fetal cells and for the detection of certain deletions, duplications, and other abnormalities in tumor cells. In contrast to metaphase FISH, interphase FISH does not permit visualization of the actual chromosomes; therefore, certain structural rearrangements or aneuploidy will not be detected.

With **metaphase FISH**, cells progress through the division process until metaphase, when chromosomes are condensed and can be individually distinguished. In contrast to interphase FISH, metaphase FISH permits visualization of the actual chromosomes as well as the general location of the abnormality on the chromosome.

Related term: aneuploidy

fluorescent in situ hybridization

See FISH.

founder effect

The higher-than-average frequency of a rare allele in a population isolated over time by geography, language, and/or culture, resulting from the presence of the allele in an early member or members ("founders") of that group. For example, a founder effect accounts for the high incidence of Huntington disease in the Lake Maracaibo region of Venezuela.

Related term: founder variant

founder variant

A pathogenic variant observed in high frequency in a specific population due to the presence of the variant in a single ancestor or small number of ancestors

Related terms: allele frequency; founder effect

frameshift variant

Synonyms: out-of-frame variant, out-of-frame deletion

A deletion, duplication, or insertion within an exon involving a number of base pairs that is not a multiple of three, consequently disrupting the triplet reading frame and usually leading to the creation of a premature termination (stop) codon and subsequent loss of normal protein product

Related term: pathogenic variant

full-penetrance allele

In autosomal dominant, autosomal recessive, and X-linked disorders caused by nucleotide repeat expansion, an abnormally large allele that is associated with disease manifestations

Related terms: anticipation; reduced-penetrance allele; trinucleotide repeat

gain-of-function

Referring to a gene variant associated with one of the following abnormalities: an increase in one or more functions of the gene product; a novel function of the gene product; a change in timing of gene expression

Related terms: loss-of-function; pathogenic variant

gDNA

Genomic DNA. The DNA in a cell that is chromosomal DNA. Genomic DNA does not include mitochondrial DNA.

Related terms: cDNA; genomic; mRNA

gene

The basic unit of heredity, consisting of a segment of DNA arranged in a linear manner along a chromosome. A gene codes for a specific protein, a segment of protein, or noncoding RNA.

Related terms: allele; genomic; genotype

gene conversion

The transfer of DNA sequences between two very similar genes, most often by unequal crossing over during meiosis; can be a mechanism for mutation if the transfer of material disrupts the coding sequence of the gene or if the transferred material itself contains one or more pathogenic variants

Related terms: pseudogene; recombination; unequal crossing over

gene product

Most genes are transcribed into segments of RNA (ribonucleic acid), which are translated into proteins. Both RNA and proteins are products expressed by the gene.

Related terms: gene; isoforms

gene-targeted array

A microarray designed to determine exon-level copy number for a gene or set of genes associated with a phenotype or specific clinical feature

Related term: exome array

gene therapy

Treatment of a genetic disorder by replacing or manipulating an abnormal gene

genetic counseling

The process of providing individuals and families with information on the nature, inheritance, and implications of genetic disorders to help them make informed medical and personal decisions. Genetic counseling deals with risk assessment and the use of family history and testing to clarify genetic status for family members.

genome sequencing

Sequence analysis of the genome including coding and noncoding regions typically performed by next-generation sequencing (NGS) of sheared genomic DNA; genome sequencing techniques have nonstandardized, highly variable coverage. Note that "genome sequencing" is preferred over the formerly used term "whole-genome sequencing" because coverage of the genome is less than 100%, and thus the "whole" genome is not sequenced.

Related terms: exome sequencing; genomic; next-generation sequencing

genomic

Referring to the human genome, which comprises the DNA in all chromosomes and in mitochondria

Related terms: gDNA; genome sequencing

genotype

Commonly, the allele or set of alleles at a single locus; less commonly, the set of alleles at multiple or all loci

genotype-phenotype correlations

Associations between an individual's genotype and the resulting pattern of clinical findings, or phenotype

Related terms: genotype; phenotype

genotyping

Molecular assay designed to detect the presence or absence of a specific variant (or variants) in DNA; variants in DNA not targeted by the assay will not be detected.

germline

The cell line from which egg or sperm cells (gametes) are derived

germline mosaicism

Synonym: gonadal mosaicism

Two or more cell lines with a different genetic composition confined to the precursor (germline) cells of the egg or sperm

Related term: somatic mosaicism

germline variant

A variant that is presumed to be present in all germ (egg and sperm) cells and somatic cells. Unlike a somatic variant (i.e., a variant that arises spontaneously in a somatic cell), a germline variant can be transmitted to offspring.

Related terms: constitutional variant; *de novo*; germline; germline mosaicism

gonadal mosaicism

See germline mosaicism.

haploid

Half the diploid or normal number of chromosomes in a somatic cell; the number of chromosomes in a gamete (egg or sperm) cell, which in humans is 23 chromosomes, one chromosome from each chromosome pair

haploinsufficiency

A cause of disease in which the protein product from a single normal allele is insufficient -- given the presence of a loss-of-function pathogenic variant on the other allele -- to prevent the appearance of an abnormal phenotype

hemizygous

Referring to a gene normally present in only a single copy; usually an X-linked gene in a male

Related terms: heterozygote; homozygous; X-linked

heteroplasmic

See heteroplasmy.

heteroplasmy

The presence within a single cell of both normal and mutated mitochondrial DNA (mtDNA); the proportion of normal to mutated mtDNA (i.e., the mutant load) may vary in different tissues and is a critical factor in the expression and severity of disease caused by mutation of mtDNA.

Related terms: mitochondrial inheritance; variable expressivity

heterozygote

An individual with two different alleles at a particular locus (one on each chromosome of a pair), one of which is usually pathogenic. The risk that an individual who is heterozygous for a pathogenic variant will have manifestations of the related phenotype depends on the specific disorder and the mode of inheritance of the disorder.

Related terms: carrier; homozygous; obligate heterozygote

heterozygous

See heterozygote.

histone

A member of the family of proteins (referred to as histones) around which nuclear DNA is wrapped to facilitate condensation into chromosomes and access for transcription. Eight histone proteins form a single histone core.

Related terms: chromosome; epigenetic; nucleosome

homoplasmic

Characterized by homoplasmy

homoplasmy

The presence of identical alleles at all mitochondrial loci within a single cell or organism

homozygous

Denoting a variant (distinct from the reference sequence) that is present on both alleles of a given gene

Related terms: compound heterozygous; heterozygote

hot spot

A DNA sequence that is highly susceptible to mutation because of some inherent instability, a tendency toward unequal crossing over, or chemical predisposition to single-nucleotide substitutions; a region where pathogenic variants are observed with greater frequency

hypomorphic

Referring to a variant characterized by partial loss of gene activity (including reduction in protein production or function)

idiopathic

Relating to or denoting a disease or condition for which the cause is unknown

imprinted

See imprinting.

imprinting

The process by which maternally and paternally derived chromosomes are uniquely chemically modified (usually by methylation), leading to different expression of a certain gene or genes on those chromosomes depending on their parental origin. Patterns of gene expression and repression vary between imprinted regions.

Related terms: methylation; trisomy rescue; uniparental disomy

inactivating

See loss-of-function.

indel

Abbreviation for an insertion (i.e., duplication) or a deletion of nucleotides, typically within a gene or coding region

Related terms: deletion; duplication; insertion

in-frame

Referring to a variant (usually a small deletion or insertion) that does not cause a shift in the triplet reading frame. Such variants can be pathogenic when they lead to the synthesis of an abnormal protein product (i.e., one with one or more missing or inserted amino acids).

insertion

Presence of extra DNA in a gene or other DNA region; may be as small as a single base or as large as one or more genes; if the insertion occurs in a coding region, it may potentially disrupt gene function. An insertion is considered a duplication when the inserted DNA is a perfect match to the adjacent DNA.

Related term: duplication

interfamilial variability

Variability in clinical presentation of a particular disorder among affected individuals from different families

Related term: intrafamilial variability

intrafamilial variability

Variability in clinical presentation of a particular disorder among affected individuals within the same immediate or extended family

Related term: interfamilial variability

intron

Noncoding sequence of DNA removed from mature messenger RNA prior to translation

Related terms: coding region; exon; intronic; splicing

intronic

Referring to DNA or variants in DNA within an intron

Related term: intron

isoelectric focusing

Method by which proteins migrate in a matrix according to the pH; an amino acid substitution can change the isoelectric point of a protein.

isoforms

Similar forms of a protein produced by different versions of messenger RNA resulting from use of different promoters, skipping of exons, or differences in splicing; may be tissue specific.

isolated

Referring to a finding that occurs in the absence of other systemic involvement

karyotype

A photographic representation of the chromosomes of a single cell, cut and arranged in pairs based on their size and banding pattern according to a standard classification

likely benign

Referring to an alteration in a gene (distinct from the reference sequence) that is very unlikely to be associated with an abnormal phenotype or increased disease risk. A likely benign variant meets most, but not all, criteria to be classified as benign according to the five-tier system for describing the clinical significance of genetic variants (see Related terms).

Related terms: benign variant; likely pathogenic; pathogenic variant; variant of uncertain significance

likely pathogenic

Referring to an alteration in a gene (distinct from the reference sequence) that is likely to be associated with an abnormal phenotype or increased disease risk. A likely pathogenic variant meets most but not all criteria to be classified as pathogenic according to the five-tier system for describing the clinical significance of genetic events. A likely pathogenic variant is considered diagnostic and can be used for clinical decision making (see Related terms).

Related terms: benign variant; likely benign; pathogenic variant; variant of uncertain significance

locus

The physical site or location of a specific gene on a chromosome. OMIM (<http://omim.org>) is the standard reference used for locus information included in *GeneReviews*.

locus name

An informally assigned abbreviation used in the process of mapping to designate a putative gene prior to gene identification; once the gene is identified, the locus name is generally replaced by a formally assigned gene symbol (which often differs from the locus name).

loss-of-function

Referring to a variant associated with partial or total loss of the function of a gene product

Related terms: gain-of-function; pathogenic variant

loss of heterozygosity

Synonym: LOH

Loss of one of the two alleles at a locus or at multiple loci leading to a homozygous or hemizygous state. LOH can be caused by a variety of genetic mechanisms including deletion, chromosome loss, and mitotic crossing over.

Related terms: deletion; hemizygous; heterozygote; homozygous

manifesting heterozygote

An individual who has at a particular locus a pathogenic variant on one chromosome and a wild type allele on the other chromosome, and who has findings of the disorder; generally refers to a clinically affected female with a heterozygous pathogenic variant in an X-linked gene. The phenotype is usually less severe than in a hemizygous male with the same pathogenic variant.

Related terms: carrier; heterozygote; X-chromosome inactivation; X-linked

methylation

The attachment of methyl groups to DNA at cytosine bases; correlated with reduced transcription of the gene and thought to be the principal mechanism in X-chromosome inactivation and imprinting

Related terms: imprinting; X-chromosome inactivation

methylation analysis

Testing that evaluates the methylation status of a gene (attachment of methyl groups to DNA cytosine bases). Genes that are methylated are not expressed.

Related terms: imprinting; methylation; sequence analysis; X-chromosome inactivation

microdeletion syndrome

See deletion syndrome.

microsatellite

Synonyms: satellite DNA, short tandem repeats

A segment of DNA two to five nucleotides in length (di-, tri-, tetra-, or pentanucleotide repeats) typically repeated five to 50 times or more. Microsatellite DNA is dispersed throughout the genome in noncoding regions between genes or within genes (i.e., in introns). Microsatellite DNA is inherently unstable and susceptible to mutation.

misattributed parentage

Refers to the situation in which a person reported to be the biological father or mother of a child is in fact not the biological parent. Factors that may result in misattributed parentage include assisted reproduction (i.e., use of a donor sperm, donor egg, or donor embryo), undisclosed adoption, and alternate paternity.

Related terms: alternate maternity; alternate paternity

mismatch repair

The DNA "proofreading" system that identifies, excises, and corrects errors in the pairing of the bases during DNA replication. Mutation of the genes encoding mismatch repair proteins can result in susceptibility to some cancers.

missense

Referring to a single base-pair substitution that results in the translation of a different amino acid at that position; can be pathogenic or benign

Related terms: benign variant; likely benign; likely pathogenic; pathogenic variant; variant of uncertain significance

mitochondrial inheritance

Synonym: maternal inheritance

Mitochondria - cytoplasmic organelles that produce the energy source ATP for most chemical reactions in the body - contain their own distinct genome; pathogenic variants in mitochondrial genes are responsible for several recognized syndromes and are always maternally inherited because mitochondria are transmitted by the ova, not the sperm.

Related terms: heteroplasmy; homoplasmy; mode of inheritance; variable expressivity

mode of inheritance

Synonyms: inheritance pattern, pattern of inheritance

The manner in which a particular genetic condition is passed from one generation to the next. Autosomal dominant, autosomal recessive, X-linked, multifactorial, and mitochondrial inheritance are examples.

molecular combing

Technique in which fluorescent in situ hybridization (FISH) probes of known sequence are hybridized to uniformly stretched long fragments of DNA to determine content of and distance between targeted sequence with high resolution. Used to assess repetitive regions of DNA not amenable to sequence analysis.

molecular genetic testing

A term widely used in clinical genetics encompassing the diverse techniques used to identify the molecular basis of genetic disease. Examples of molecular genetic tests include: genotyping to detect specific pathogenic variants; sequencing of a gene to detect pathogenic variants; amplification or hybridization methods (e.g., qPCR, array CGH, MLPA) to detect copy number variants involving one or more genes; methylation-specific techniques to detect epigenetic changes that influence gene expression; and exome and genome sequencing.

monoallelic

Referring to one allele of a gene pair, as opposed to biallelic, which refers to both alleles of a gene pair.

Related terms: heterozygous; *cis*

monosomy

The presence of only one chromosome from a pair; partial monosomy refers to the presence of only one copy of a segment of a chromosome

mosaicism

Within a single individual or tissue, the occurrence of two or more cell lines with a different genetic or chromosomal composition. Mosaicism may involve somatic cells, germline cells, and/or tumor cells.

Related terms: germline mosaicism; germline variant; postzygotic; somatic mosaicism

mRNA

Messenger RNA

multifactorial

Referring to the combined contribution of one or more often unspecified genes and environmental factors, often unknown, in the causation of a particular finding

multigene panel

Simultaneous molecular testing of multiple genes associated with the same or similar clinical phenotypes. The genes included in the panel and the diagnostic sensitivity of the testing used for each gene vary by laboratory and over time. Methods used may include sequence analysis, deletion/duplication analysis, or other non-sequencing-based tests.

next-generation sequencing (NGS)

Synonyms: massively parallel sequencing (MPS), high-throughput sequencing

Referring to several different technologies, all of which allow simultaneous sequence analysis of millions of DNA fragments. NGS can detect variations as small as a single-base substitution; depending on the methods used, NGS may detect copy number variants (CNVs). NGS is used primarily for multigene panels and genome, exome, and transcriptome sequencing. NGS may also be used for single-gene testing (e.g., targeting of a single gene on a mult-gene panel or sequencing of a large multiexon gene). Results from NGS may require confirmation by an alternative sequencing method.

Related terms: copy number variant; exome sequencing; genome sequencing; multigene panel; sequence analysis; single-nucleotide variant

nonallelic homologous recombination

Synonym: NAHR

The result of a process in which segmental duplications (low copy repeats) flanking a region misalign during meiosis, followed by unequal crossing over between the segmental duplications. The process can produce gametes with the recurrent deletion or the reciprocal recurrent duplication.

Related term: unequal crossing over

noncoding RNA

Functional RNA (transcribed from a gene) that is not translated into protein

nonsense

Referring to a variant in which a codon is changed from one that specifies an amino acid to one that specifies a termination (stop)

normal variant

See benign variant.

nucleosome

The functional unit of a chromosome, consisting of the length of DNA and the core of histone proteins around which DNA is wrapped. The nucleosome is the building block of the chromosome.

Related terms: chromosome; histone

nucleotide repeat

Sequence of n nucleotides repeated a number of times in tandem; can occur within or near a gene. The size of nucleotide repeats varies: smaller numbers of repeats are common and not associated with phenotypic abnormalities; abnormally large numbers of repeats may be associated with phenotypic abnormalities and are

classified as (in increasing order): mutable normal alleles, premutations, reduced-penetrance alleles, and full-penetrance alleles.

Related terms: premutation; trinucleotide repeat

null

Referring to a pathogenic variant that results in either no mRNA, no protein, or a nonfunctional protein

obligate heterozygote

An individual who must be heterozygous for a variant based on analysis of the family history; applies to disorders inherited in an autosomal recessive or X-linked manner. The term "obligate heterozygote" can also refer to individuals with an autosomal dominant disorder whose position in a pedigree indicates that they must be heterozygous even though they do not manifest the phenotype.

Related terms: autosomal dominant; autosomal recessive; carrier; heterozygote; X-linked

oligogenic

Referring to a phenotype expressed only in the presence of pathogenic variants in more than one gene; may be referred to (with less precision) as multigenic or polygenic

Related terms: digenic; trigenic

open reading frame

See coding region.

pathogenic variant

An alteration in a gene (distinct from the reference sequence) that is associated with an abnormal phenotype or increased disease risk. A pathogenic variant meets criteria to be classified as pathogenic according to the five-tier system for describing the clinical significance of genetic variants (see Related terms).

Related terms: benign variant; likely benign; likely pathogenic; variant of uncertain significance

PCR

Synonym: polymerase chain reaction

A procedure that produces millions of copies of a short segment of DNA through repeated cycles of: (1) denaturation, (2) annealing, and (3) elongation. PCR is commonly used either: (a) to generate a sufficient quantity of DNA to perform a test (e.g., sequence analysis); or (b) as a test in and of itself (e.g., allele-specific amplification, trinucleotide repeat quantification).

Related terms: quantitative PCR; sequence analysis; targeted analysis for pathogenic variants; X-chromosome inactivation

pedigree

A diagram of the genetic relationships and medical history of a family using standard symbols and terminology

Related terms: consanguineous; obligate heterozygote; proband

penetrance

The proportion of individuals with a pathogenic variant causing a particular disorder who exhibit clinical findings of that disorder; most often refers to autosomal dominant conditions.

Related terms: autosomal dominant; intrafamilial variability; variable expressivity

phenotype

The observable characteristics of the expression of a gene; the clinical presentation of an individual with a particular genotype

Related terms: allelic heterogeneity; dysmorphic; genotype; genotype-phenotype correlations; variable expressivity

polygenic

Referring to a condition caused by the additive contributions of variants in multiple genes at different loci

polymerase chain reaction

See PCR.

polymorphism

A natural variation in a gene, DNA sequence, protein, or chromosome that has no adverse effect on the individual

Related terms: allele; benign variant; variant of uncertain significance

postzygotic

Referring to a pathogenic variant or abnormality in chromosome replication/segregation/methylation that occurs after fertilization of the ovum by the sperm, often leading to mosaicism (two or more genetically distinct cell lines within the same organism)

Related terms: germline mosaicism; mosaicism; somatic mosaicism; trisomy rescue

preimplantation genetic diagnosis

See preimplantation genetic testing.

Related terms: molecular genetic testing; polymerase chain reaction (PCR); prenatal testing; targeted analysis for pathogenic variants

preimplantation genetic testing

Synonyms: PGT, preimplantation testing

Genetic testing of one or more cells removed from early embryos conceived by in vitro fertilization and transferring to the mother's uterus only those embryos determined not to have the pathogenic variant(s)/ chromosome anomaly(ies) of concern

Related terms: molecular genetic testing; polymerase chain reaction (PCR); prenatal testing; targeted analysis for pathogenic variants

premutation

An allele in which a tandemly repeated nucleotide sequence within or near a gene contains more repeats than a normal allele. A premutation allele can expand into a full-penetrance allele (repeat size associated with disease) when passed through the germline. Although premutation alleles are not typically associated with disease, in rare instances they are; the best example is premutation *FMRI* alleles, which are associated with disease phenotypes distinct from fragile X syndrome (which is caused by full-penetrance *FMRI* alleles).

prenatal diagnosis

See prenatal testing.

prenatal testing

Testing performed during pregnancy. Prenatal testing may be used to determine if a fetus is affected with a particular disorder. Invasive procedures such as chorionic villus sampling (CVS), amniocentesis, or periumbilical blood sampling (PUBS) are used to obtain a sample for testing; imaging (e.g., ultrasound, MRI) is used to evaluate fetal anatomy.

private

Referring to a variant that does not have appreciable allele frequency in the general population; a private variant may be benign or pathogenic; historically used to describe a variant thought to occur in a single family

proband

Synonyms: propositus, index case

The affected individual through whom a family with a genetic disorder is ascertained; may or may not be the individual presenting for genetic counseling

Related terms: pedigree

promoter region

A region of DNA (just upstream of a gene) that acts as a binding site for transcription factors and RNA polymerase to initiate transcription

pseudodominant inheritance

An autosomal recessive condition present in individuals in two or more generations of a family, thereby appearing to follow a dominant inheritance pattern; occurs as a result of reproduction between an affected individual and a carrier partner

pseudogene

A copy of a gene that is transcriptionally or translationally inactive due to accumulation of inactivating variants. Pseudogenes are classified as either non-processed (includes introns) or processed (does not include introns).

Related terms: deletion; duplication; unequal crossing over

quantitative PCR

Synonyms: kinetic quantitative PCR, real time quantitative PCR

A form of PCR used to determine the relative amount of DNA or RNA in a sample; commonly used to detect heterozygous deletions and duplications

Related terms: deletion; duplication; heterozygote; PCR; targeted analysis for pathogenic variants

recombination

The exchange of a segment of DNA between two homologous chromosomes during meiosis leading to a novel combination of genetic material in the gamete

recurrence risk

The likelihood that a trait or disorder present in one family member will occur again in other family members in the same or subsequent generations

recurrent deletion

Deletion of a specific size - usually mediated by nonallelic homologous recombination (NAHR) - occurring multiple times in the general population

Related term: nonallelic homologous recombination

reduced-penetrance allele

An alteration in a gene (distinct from the reference sequence) that is associated with an abnormal phenotype or increased disease risk in some (not all) individuals who have the alteration

revertant mosaicism

Presence of two or more cell lines in one individual that have different genetic compositions - one or more cell lines having a germline pathogenic variant and the other(s) derived from spontaneous somatic correction of the germline pathogenic variant to the normal (wild type) state

Related terms: germline variant; mosaicism; somatic mosaicism

Robertsonian translocation

The joining of two acrocentric chromosomes at the centromeres with loss of their short arms to form a single abnormal chromosome; in acrocentric chromosomes the centromere is located near the end of the chromosome. Acrocentric chromosomes are 13, 14, 15, 21, and 22.

Related terms: chromosome; deletion; duplication

Sanger sequencing

A method of DNA sequencing that uses DNA polymerase to copy single-stranded DNA templates by adding nucleotides to form a complementary strand. Its use is limited to sequence analysis of a single region of DNA (maximum ~1000 bp) - in contrast to massively parallel sequencing, in which millions of fragments of DNA can be sequenced simultaneously.

Related terms: deletion/duplication analysis; molecular genetic testing; PCR; targeted analysis for pathogenic variants

second-degree relative

A relative who shares one quarter of an individual's genes is shared (i.e., grandparent, grandchild, uncle, aunt, nephew, niece, half-sib)

segregation

The separation of the homologous chromosomes and their random distribution to the gametes at meiosis

sensitivity

The frequency with which testing yields a positive result when the individual being tested either (a) is actually affected (clinical sensitivity) or (b) has a pathogenic variant detected by molecular genetic testing (analytic sensitivity)

sequence alteration

Synonym: variant

Any alteration in a gene from its natural state; may be benign (may be referred to as a "polymorphism"), pathogenic, or of uncertain significance

Related terms: benign variant; likely benign; likely pathogenic; pathogenic variant; variant of uncertain significance; wild type

sequence analysis

Synonym: sequencing

Process by which the nucleotide sequence for a segment of DNA is determined

Related terms: molecular genetic testing; next-generation sequencing; PCR; Sanger sequencing; targeted analysis for pathogenic variants

simplex

Referring to a single occurrence of a disorder in a family

single-nucleotide variant

Synonyms: SNV, point mutation

An alteration in DNA sequence caused by a single-nucleotide base change, insertion, or deletion; can be benign, pathogenic, or of uncertain significance

sister chromatid exchange

Synonym: SCE

Exchange of genetic material between the two chromatids of a single chromosome during the cell division process; similar to crossing over (recombination), except that the exchange involves the two sister chromatids of a single chromosome, whereas crossing over refers to exchange of genetic material between the two homologous chromosomes of a chromosome pair

SNP array

Method used in a given individual to genotype single-nucleotide polymorphisms (SNPs) across the genome to identify: (1) copy number variants; (2) regions of uniparental disomy; (3) evidence of parental consanguinity

Related terms: chromosomal microarray; comparative genomic hybridization; copy number variant; single-nucleotide variant; uniparental disomy

somatic mosaicism

Two or more cell lines with a different genetic composition within the cells of an individual (may or may not include the germline cells)

Related term: germline mosaicism

somatic pathogenic variant

Variant resulting from mutation that occurs during embryonic development (i.e., that is not inherited from a parent)

Southern blot

Synonyms: Southern analysis, Southern blot analysis

Technique used to detect differences in the lengths of DNA fragments occurring as a result of a variant or gene rearrangement

Related terms: molecular genetic testing; targeted analysis for pathogenic variants

splice site

The junction between an intron and an exon in a DNA sequence; the site of intron/exon splicing. A variant in the splice site can cause abnormal removal of introns and splicing together of exons such that one or more introns remaining in the mRNA can potentially disrupt generation of the protein product.

splicing

The process by which introns (noncoding regions) are excised out of the primary messenger RNA transcript and exons (i.e., coding regions) are joined together to generate mature messenger RNA

sporadic

Referring to the chance occurrence of a disorder or abnormality that is not expected to recur in a family

Related terms: recurrence risk; simplex

syndromic

In *GeneReviews*: referring to a disorder characterized by a constellation of phenotypic features that either: (1) specifically suggest the diagnosis (which can be confirmed by molecular genetic testing); or (2) allow diagnosis of the disorder in the absence of confirmatory molecular genetic findings

targeted analysis for pathogenic variants

Testing for specific variants known to cause disease. Examples include: (1) one or more specific pathogenic variants (e.g., Glu6Val for sickle cell anemia, a panel of pathogenic variants for cystic fibrosis); (2) a nucleotide repeat expansion (e.g., the trinucleotide repeat expansion associated with Huntington disease); and (3) common deletions (e.g., population-specific alpha globin gene deletions).

targeted mutation analysis

See targeted analysis for pathogenic variants.

trans

Synonym: *trans* configuration

Referring to two heterozygous variants on opposite homologous chromosomes (typically used to describe variants within the same gene)

Related term: *cis*

transcription factor

A protein that binds to DNA and either activates or represses transcription of one or more genes

translocation

Synonym: chromosome rearrangement

A chromosome alteration in which a whole chromosome or segment of a chromosome becomes attached to or interchanged with another whole chromosome or segment

Balanced translocations (in which there is no apparent net loss or gain of chromosome material) are usually not associated with phenotypic abnormalities, although gene disruptions at the breakpoints of the translocation can, in some cases, cause adverse effects, including some known genetic disorders.

Unbalanced translocations (in which there is loss or gain of chromosome material) are nearly always associated with an abnormal phenotype.

Balanced and unbalanced translocations can be visualized by karyotype analysis; chromosomal microarray (CMA) cannot detect balanced translocations.

trigenic

Referring to expression of a phenotype that requires the presence of pathogenic variants in three different genes

Related terms: digenic; oligogenic

trinucleotide repeat

Sequences of three nucleotides repeated a number of times in tandem within a gene

Related terms: anticipation; nucleotide repeat; premutation; targeted analysis for pathogenic variants

trisomy rescue

The phenomenon in which a fertilized ovum initially contains 47 chromosomes (i.e., one chromosome is trisomic), but loses one of the trisomic chromosomes in the process of cell division such that the resulting daughter cells and their descendants contain 46 chromosomes, the normal number

Related terms: aneuploidy; imprinting; postzygotic; uniparental disomy

uncertain significance

A variant of uncertain significance (VOUS, VUS) is an alteration in a gene (distinct from the reference sequence) that may or may not be disease-causing or associated with increased risk of an abnormal phenotype; the identification of a variant of uncertain significance neither confirms nor rules out a diagnosis. A variant of uncertain significance does not meet criteria to be classified as pathogenic or benign according to the five-tier system for describing the clinical significance of genetic variants (see Related terms). Sequence analysis may identify multiple variants of uncertain significance in a given gene or hundreds to thousands in the human exome.

Related terms: benign variant; likely benign; likely pathogenic; pathogenic variant

unequal crossing over

Exchange of DNA during meiosis between improperly aligned segments of DNA that can result in a gain or loss of DNA. Circumstances that predispose to unequal crossing over are misalignment of: (1) highly homologous segment duplications (low copy repeats) referred to as nonallelic homologous recombination which result in recurrent deletions or duplications; and (2) a gene and its pseudogene in tandem on a chromosome (e.g., *CYP21* and its pseudogene *CYP21P*; *GBA1* [formerly *GBA*] and its pseudogene *GBA1LP* [formerly *GBAP*]) which result in *de novo* pathogenic variants.

See nonallelic homologous recombination.

Related terms: deletion; duplication; gene conversion; recombination

uniparental disomy

Synonym: UPD

The situation in which both copies of a chromosome pair (or chromosome pair segment) are from one parent (i.e., no copy is from the other parent). The individual may have two identical copies of one of the pair of parental chromosomes (termed **uniparental isodisomy**), or may have one copy of each of the parental chromosome pair (termed **uniparental heterodisomy**). Uniparental disomy can result in an abnormal phenotype in some instances.

Related terms: imprinting; trisomy rescue; uniparental heterodisomy; uniparental isodisomy

uniparental heterodisomy

The situation in which an individual inherits both copies of a chromosome pair (or chromosome pair segment) from one parent; no copy is inherited from the other parent (compare **uniparental isodisomy**).

Related terms: imprinting; trisomy rescue; uniparental disomy; uniparental isodisomy

uniparental isodisomy

The situation in which an individual inherits two identical copies of one of a chromosome pair (or chromosome pair segment) from one parent; no copy is inherited from the other parent (compare **uniparental heterodisomy**).

Related terms: imprinting; trisomy rescue; uniparental disomy; uniparental heterodisomy

unknown significance

See uncertain significance.

variable expressivity

Variation in clinical features (type and severity) of a genetic disorder between affected individuals, even within the same family

Related terms: interfamilial variability; intrafamilial variability

whole-exome sequencing

See exome sequencing.

whole-genome sequencing

See genome sequencing.

wild type

Referring to a normal, fully functional gene or allele

X-chromosome inactivation

Synonym: lyonization

In females, the phenomenon by which one X chromosome (either maternally or paternally derived) is randomly inactivated in early embryonic cells, with fixed inactivation in all descendant cells; first described by the geneticist Mary F Lyon, PhD.

Related terms: manifesting heterozygote; X-linked

X-linked

Referring to a gene on the X chromosome or to the mode of inheritance in which the causative pathogenic variant is on the X chromosome; hemizygous males will be affected; heterozygous females may or may not be affected depending on the disorder and factors influencing X-chromosome inactivation.

Related terms: hemizygous; heterozygote; mode of inheritance; X-chromosome inactivation

X-linked dominant

See X-linked.

X-linked recessive

See X-linked.

Learn More (allele).

Alleles may be pathogenic (i.e., known to be associated with disease), benign, or of uncertain significance. The term "mutated allele" implies that the allele is pathogenic.

Types of alleles designated by the transmitting parent:

- Maternal allele. Inherited from the mother
- Paternal allele. Inherited from the father

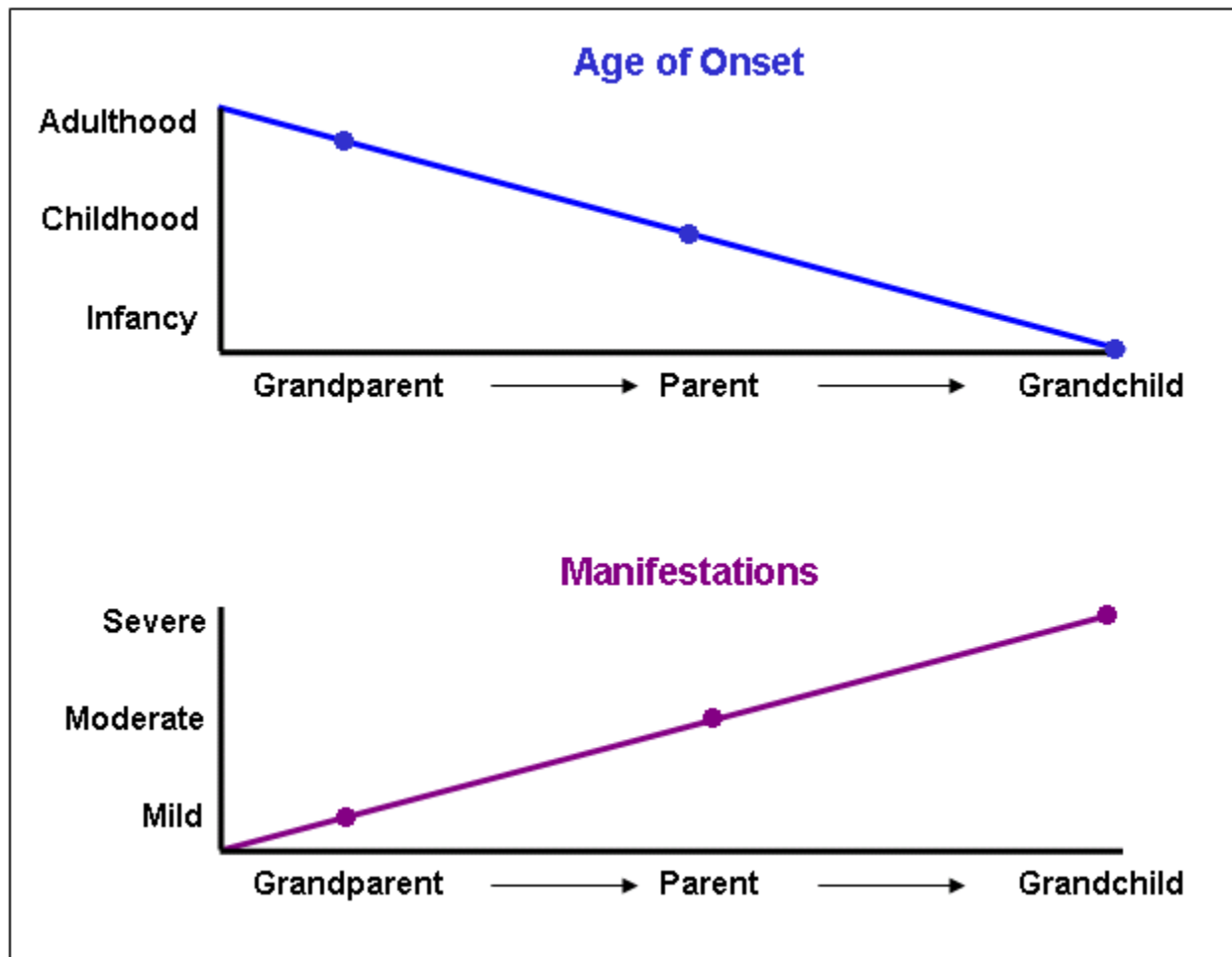
Paternal and maternal alleles may be:

- Homozygous. Identical wild type or identical pathogenic alleles
- Heterozygous. Two different alleles (both wild type, both pathogenic, or one wild type and one pathogenic allele)
- Compound heterozygous. Two different pathogenic alleles

Updated: 4-13-16

Related terms: allele frequency; benign variant; compound heterozygous; heterozygote; homozygous; likely benign; likely pathogenic; locus; pathogenic variant; polymorphism; variant of uncertain significance; wild type

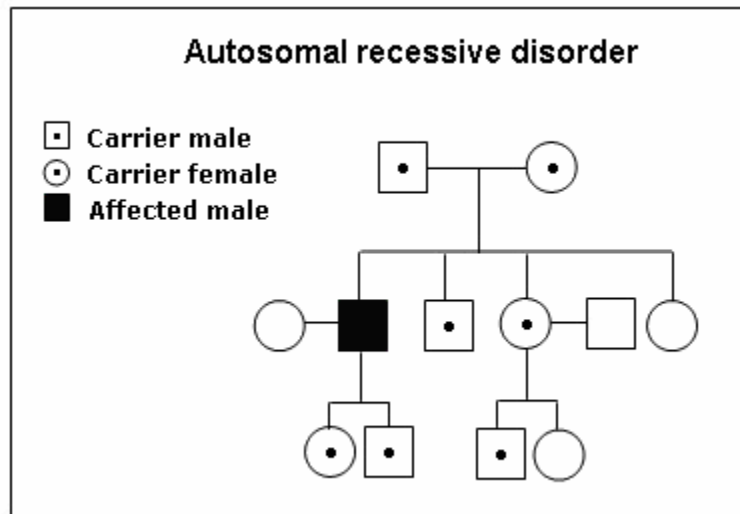
[Instructions](#)

Learn More (anticipation).

Posted: 10-1-02

Related terms: intrafamilial variability; nucleotide repeat; trinucleotide repeat; variable expressivity

[Instructions](#)

Learn More (carrier).

In an autosomal recessive disorder:

- The parents of an affected individual are carriers.
- The unaffected sibs of an affected individual are at a 2/3 risk of being carriers.
- The offspring of an affected individual and a non-carrier are carriers.
- The offspring of a carrier and a non-carrier are at a 50% risk of being carriers.

Revised: 4-13-16

Related terms: autosomal recessive; carrier rate; carrier testing; compound heterozygous; heterozygote; obligate heterozygote

Instructions

Learn More (carrier rate).

Individuals who carry a single recessive pathogenic variant usually cannot be identified by their phenotype (i.e., they are unaffected); carrier frequency can be estimated using the Hardy-Weinberg Law when the disease frequency (i.e., homozygote frequency) is known.

continues on next page...

continued from previous page.

Hardy-Weinberg Law

$$(p+q)^2 = 2pq + q^2$$

Assume $p + q = 1$
where:

p = frequency of one allele at one locus (i.e., dominant allele 'A')

q = frequency of another allele at the same locus on the homologous chromosome (i.e., recessive allele 'a')

p^2 = frequency of homozygotes for dominant allele (i.e., 'AA' genotype)

q^2 = frequency of homozygotes for recessive allele (i.e., 'aa' genotype)

$2pq$ = frequency of heterozygotes (i.e., 'Aa' genotype)

	A	a
A	AA	Aa
a	Aa	aa

Calculating carrier rate ($2pq$) for an autosomal recession condition using the Hardy-Weinberg Law when disease frequency (q^2) is known:

Disease frequency (q^2) = $1/2000$; $q = \sqrt{1/2000} = 0.022$

Since $p + q = 1$, $p = 1 - 0.022 = 0.978$

Therefore, $2pq = 2(0.978)(0.022) = 0.043$ or $\sim 4\%$

The carrier rate for this recessive condition is $\sim 4\%$ (or 1:25 individuals), given a disease frequency in this population of 1:2000.

Edited: 4-13-16

Related terms: allele frequency; carrier; heterozygote

Instructions

Learn More (carrier testing).

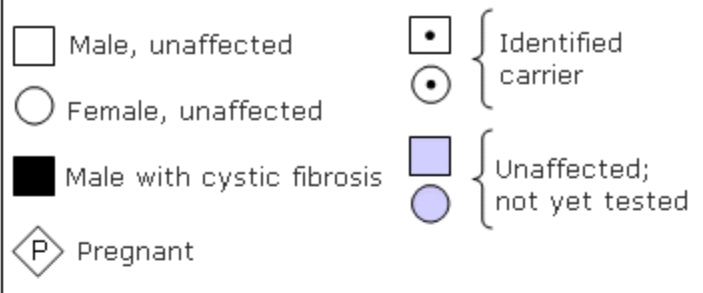
Carrier testing is traditionally offered to individuals who:

- Have family members with a genetic condition;
- Have family members who are identified carriers;
- Are members of ethnic or racial groups known to have a higher carrier rate for a particular condition.

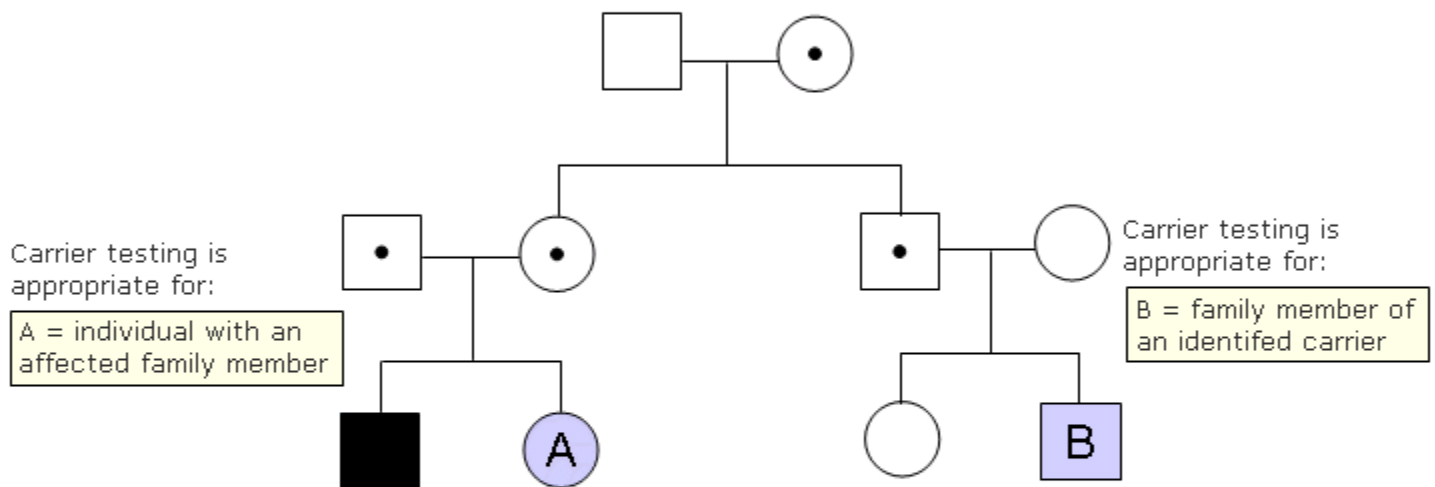
continues on next page...

continued from previous page.

Key

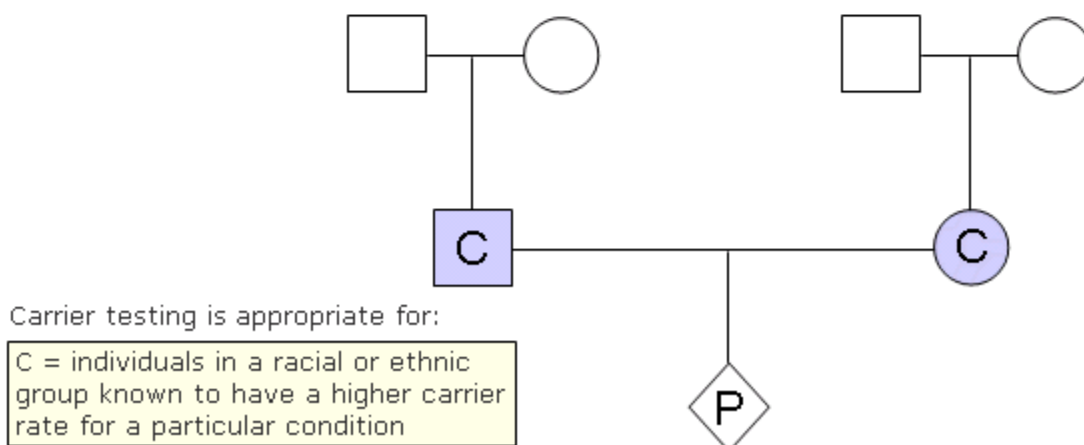


Family with cystic fibrosis



African American

African American



Approximately one in ten individuals of African American ancestry is a carrier for sickle cell anemia.

Revised: 11-3-16

Related terms: autosomal recessive; carrier; heterozygote; molecular genetic testing; pathogenic variant; X-linked

Instructions

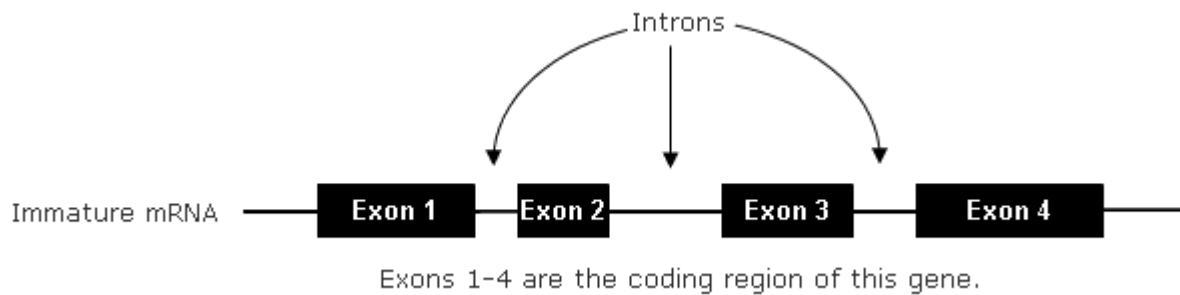
Learn More (coding region).

Figure 1. DNA initially transcribed to immature messenger RNA (mRNA) consists of coding sequences (exons) and noncoding sequences (introns).

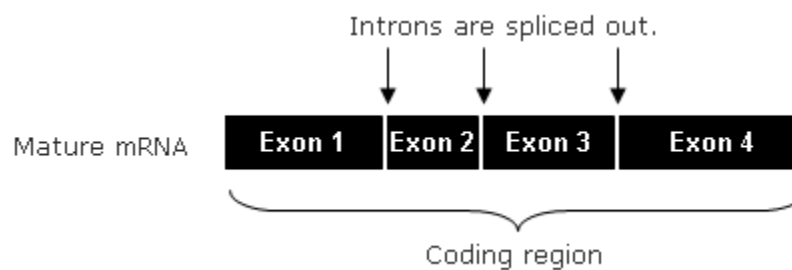


Figure 2. Introns have been spliced out of the immature mRNA to form mature mRNA, leaving only the exons to ultimately encode the amino acid product.

Illustrations adapted from Nussbaum RL, McInnes RR, Willard HF, eds: *Thompson & Thompson Genetics in Medicine*, 6 ed. The human genome: structure and function of genes and chromosomes, Fig 3-6, p 20. Copyright 2001, with permission from Elsevier.

Posted: 12-31-03

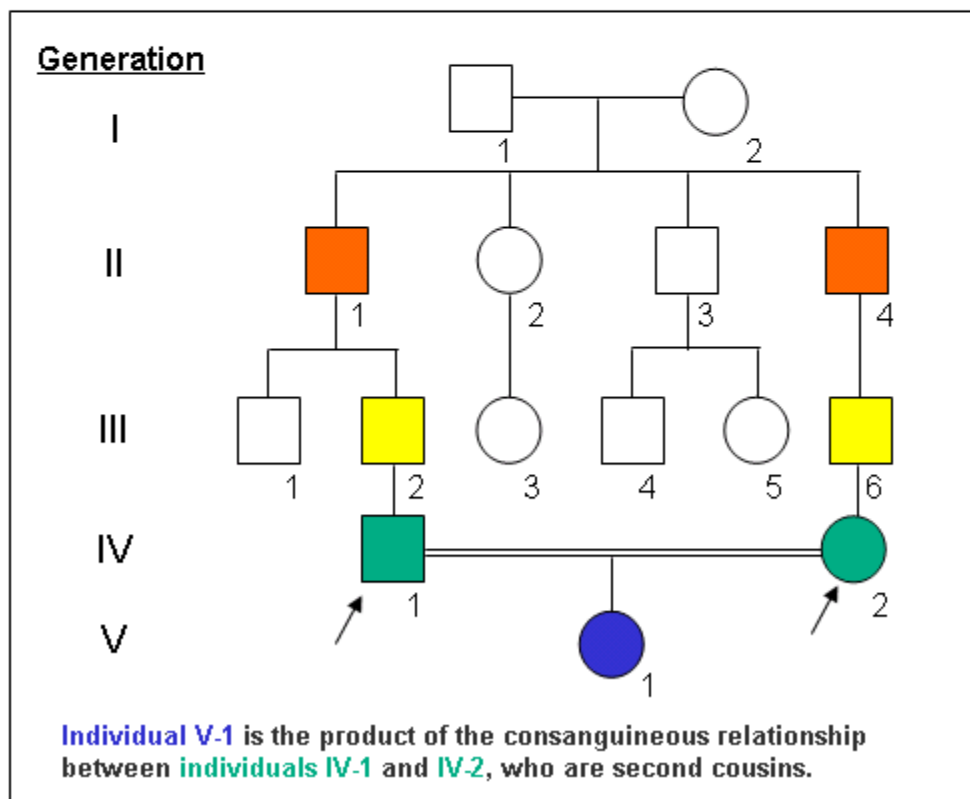
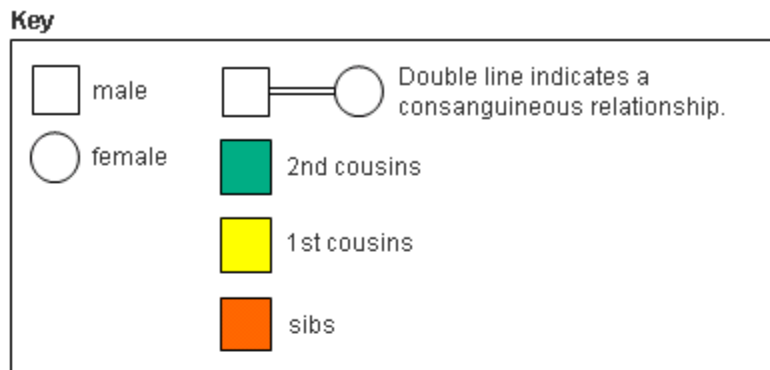
Related terms: exome sequencing; exon; intron; promoter region

Instructions

Learn More (consanguineous).**Pedigree depicting the offspring of second cousins**

continues on next page...

continued from previous page.



Revised: 4-14-16

Related terms: autosomal recessive; pedigree

Instructions

Learn More (deletion/duplication analysis).

The method used to detect a deletion or duplication varies by the size of the CNV.

Method ¹	Size of Deletion or Duplication (in bp, kb, or Mb)				
		1-10 bp	>10-1000 bp	>1-10 kb	>10-1000 kb

continues on next page...

continued from previous page.

Sanger sequencing	Yes	Possible ²	No	No	No
NGS	Yes	Possible ²	No ³	No ³	No ³
MLPA ⁴	No	Yes	Possible	No	No
Quantitative PCR ⁴	No	Yes	Possible	No	No
Long-range PCR ^{4, 5}	No	No	Possible	Possible	No
Gene-targeted aCGH ⁶	No	Yes ⁶	Yes	Yes	Yes
CMA	No	No	Possible	Yes	Yes
FISH	No	No	No	Possible	Yes
Karyotype	No	No	No	No	Possible starting at ~3 Mb

bp = base pairs; kb = kilobases; Mb = megabases

1. For detailed descriptions see definitions for individual methods.

2. Deletions and duplications with breakpoints falling within PCR amplification primers (Sanger sequencing) or within enrichment targeted regions (NGS) may be detected by these methods.

3. Methods to call copy number changes from NGS data are currently being developed.

4. This method is designed to detect CNVs in targeted regions only, typically deletions or duplications of one or a few exons. The size of large deletion of the region surrounding the targeted region will not be recognized and the breakpoints cannot be defined by this method.

5. This is a targeted assay that can detect known or suspected deletions in the region of interest (see targeted analysis for pathogenic variants).

6. This method is designed to detect single-exon deletions or duplications, but also contains genome-wide backbone probes that can detect larger deletions and duplications.

Posted: 6-14-16

Related terms: chromosomal microarray; deletion; duplication; FISH; next-generation sequencing; PCR; Sanger sequencing; targeted analysis for pathogenic variants

Instructions

Learn More (exon).

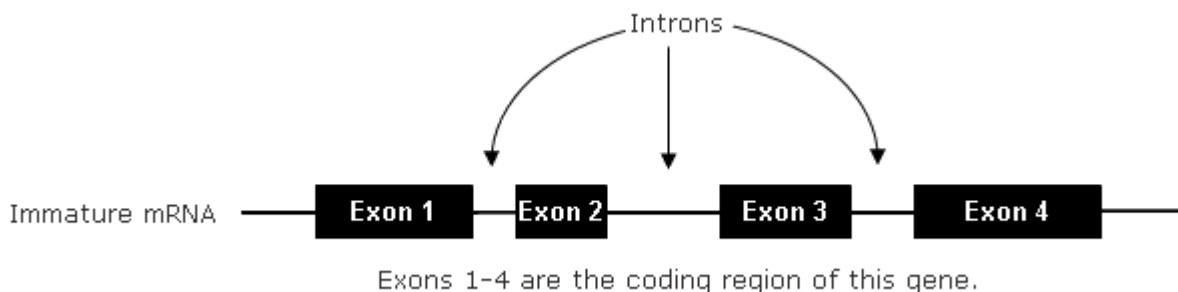


Figure 1. DNA initially transcribed to immature messenger RNA (mRNA) consists of coding sequences (exons) and noncoding sequences (introns).

continues on next page...

continued from previous page.

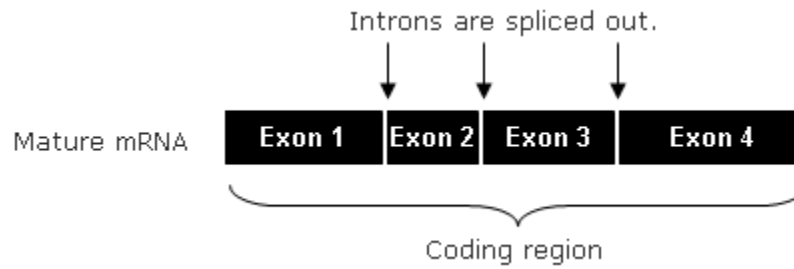


Figure 2. Introns have been spliced out of the immature mRNA to form mature mRNA, leaving only the exons to ultimately encode the amino acid product.

Illustrations adapted from Nussbaum RL, McInnes RR, Willard HF, eds: *Thompson & Thompson Genetics in Medicine*, 6 ed. The human genome: structure and function of genes and chromosomes, Fig 3-6, p 20. Copyright 2001, with permission from Elsevier.

Posted: 12-31-03

Related terms: coding region; exome sequencing; intron; open reading frame

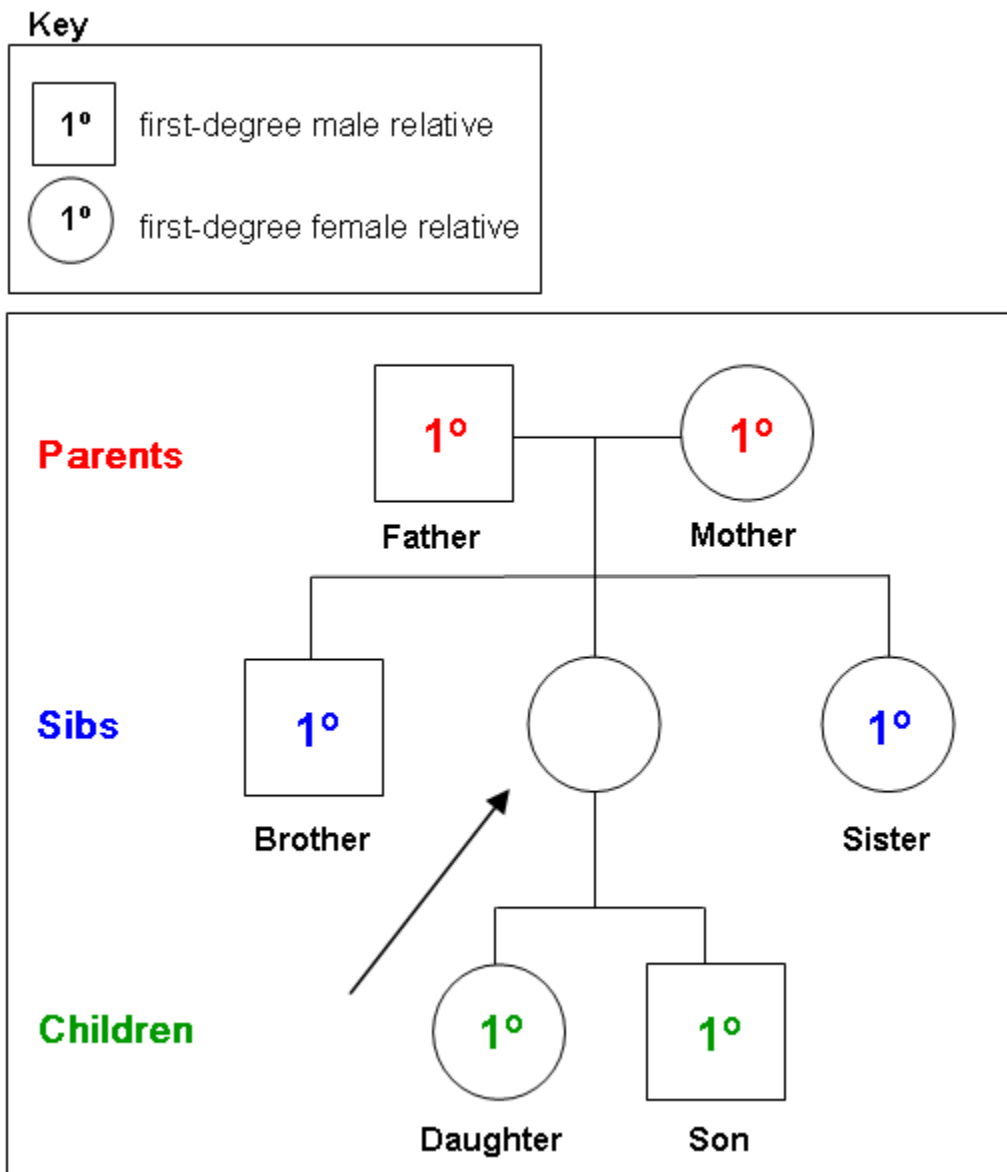
Instructions

Learn More (first-degree relative).

First-degree relatives of the person indicated by the arrow are parents, sibs, and children.

continues on next page...

continued from previous page.



Some Clinical Implications.

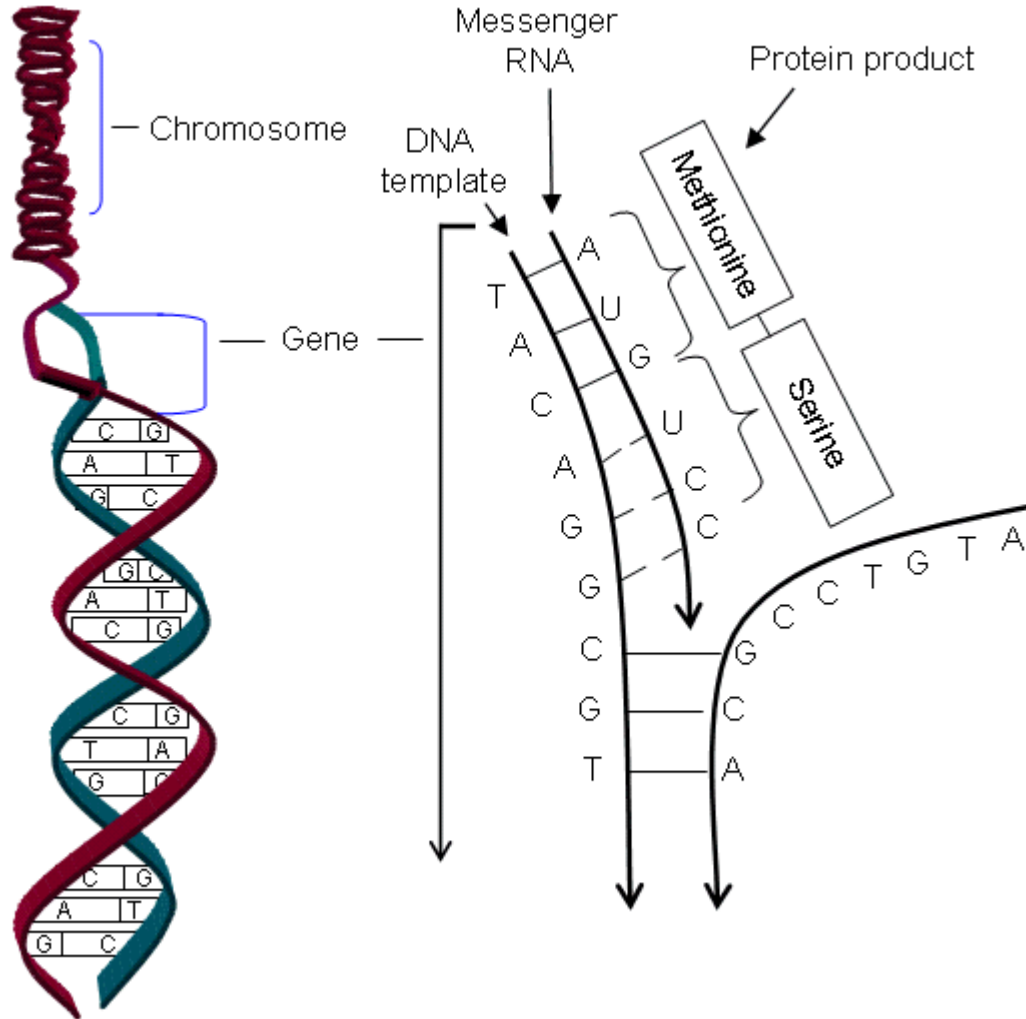
- An individual shares half of his/her genes with each parent and each child.
- An individual shares an on average half of his/her genes with each sib.

Revised: 4-14-16

Related terms: pedigree; second-degree relative

Instructions

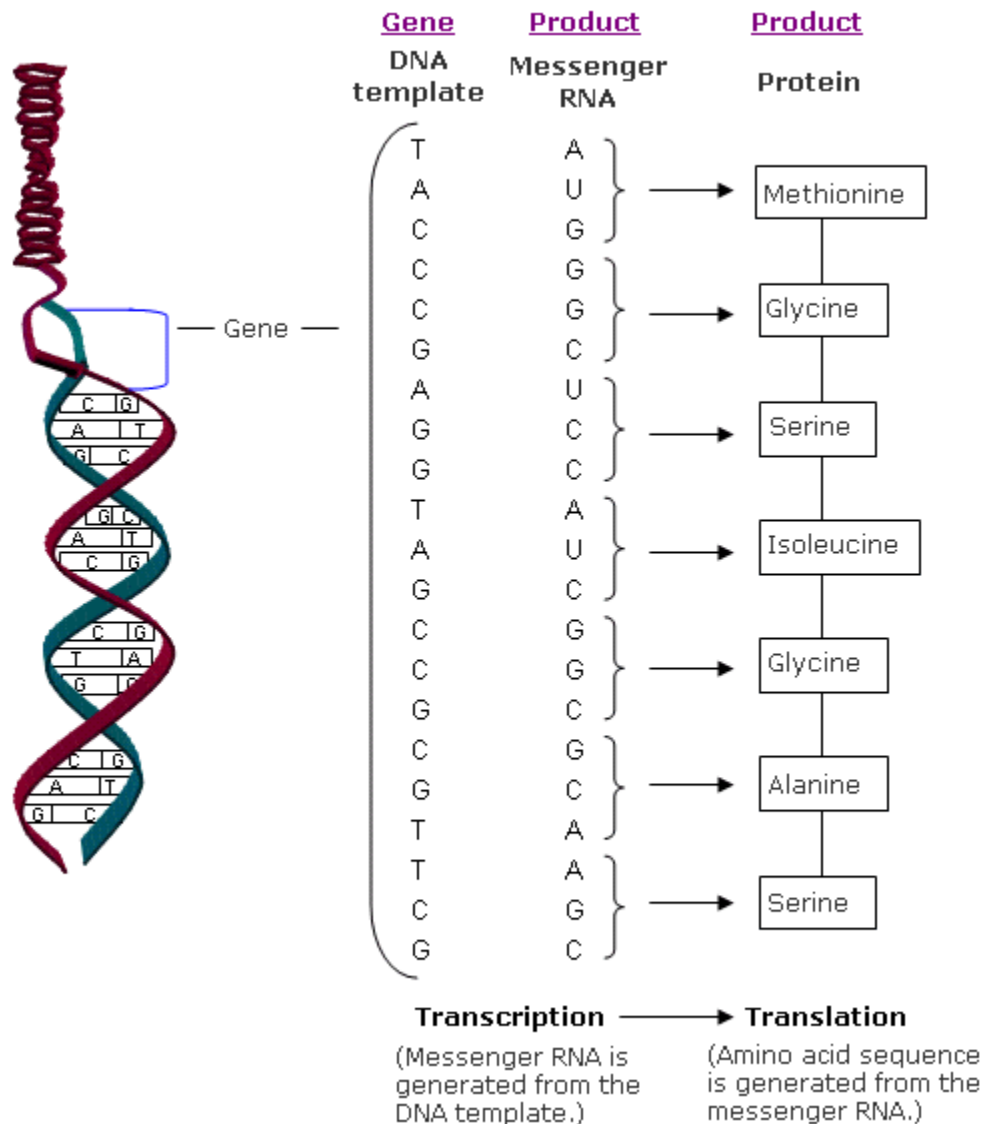
Learn More (gene).



Posted: 10-29-03

Related terms: allele; genomic; genotype

[Instructions](#)

Learn More (gene product).**Posted:** 11-10-03

Related terms: gene; isoforms

[Instructions](#)**Learn More (germline mosaicism).**

Germline mosaicism for a specific genetic condition occurs when an individual has two populations of cells in the gonads (testes or ovaries). One population of cells contains only wild type alleles. The other population of cells contains a pathogenic variant or a chromosome anomaly. Germline mosaicism is the result of sporadic mutation or chromosome alteration in a cell that will give rise to gamete cells. The pathogenic variant or chromosome anomaly is confined to the individual's germline and is not present in other cells of the body.

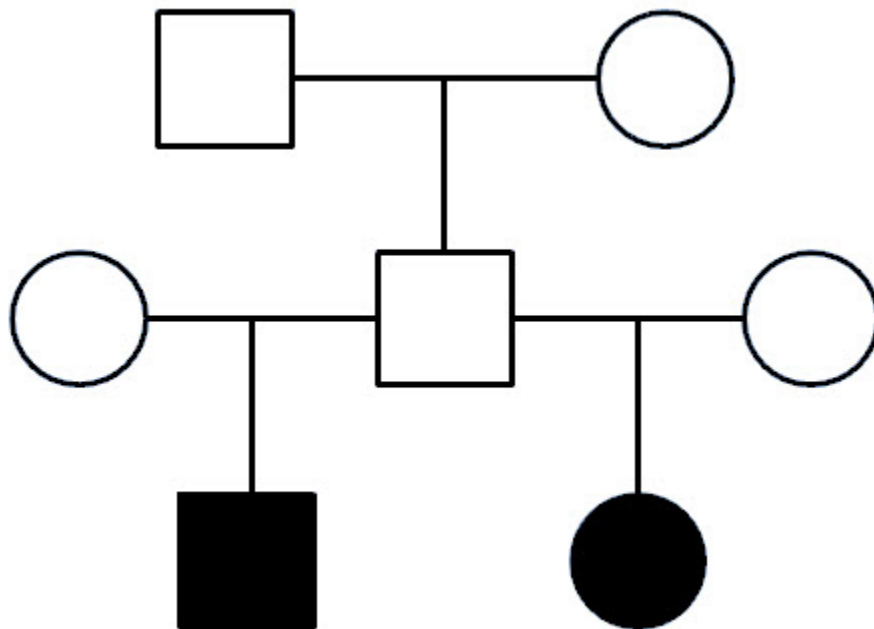
continues on next page...

continued from previous page.

Germline mosaicism is typically seen in autosomal dominant or X-linked disorders. It becomes evident or suspected when an unaffected parent has two or more children with the same pathogenic variant or chromosome anomaly, which is not present in the leukocyte DNA of either parent.

Molecular genetic testing using blood or tissue samples (other than germline tissue) from an individual with germline mosaicism will not identify the pathogenic variant or chromosome anomaly that is present in the germline.

The recurrence risk for a genetic condition is proportionate to the number of gamete cells that contain the pathogenic variant or chromosome anomaly. Germline mosaicism has been reported in numerous genetic conditions; some genetic conditions are associated with a higher risk for germline mosaicism (e.g., Duchenne muscular dystrophy, osteogenesis imperfecta).



Germline mosaicism for this fully penetrant autosomal dominant condition is suspected in the father because he has two affected children and is not affected himself.

Revised: 4-22-16

Related term: somatic mosaicism

Instructions

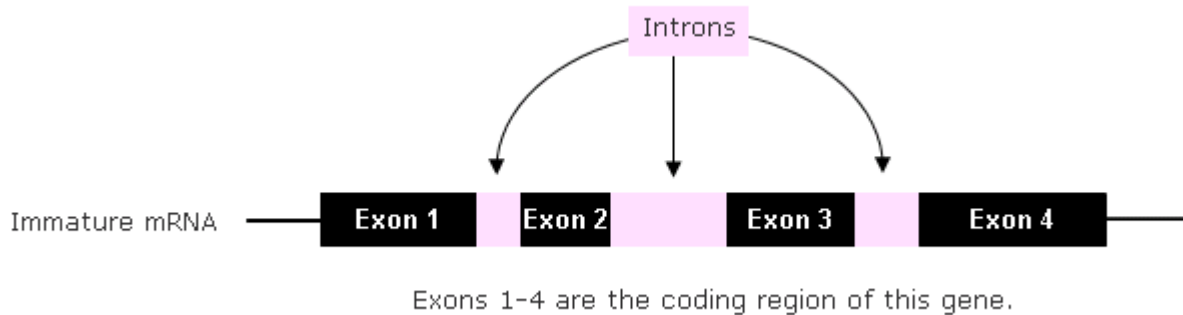
Learn More (intron).

Figure 1. DNA initially transcribed to immature messenger RNA (mRNA) consists of coding sequences (exons) and noncoding sequences (introns).

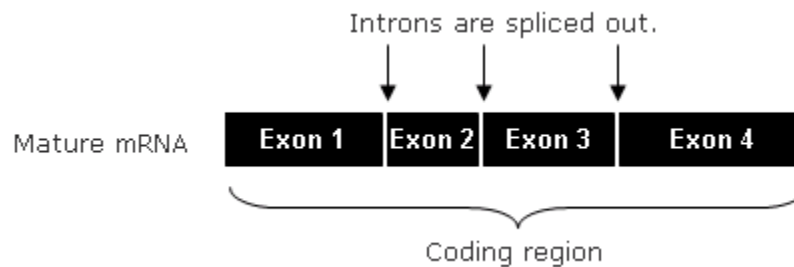


Figure 2. Introns have been spliced out of the immature mRNA to form mature mRNA, leaving only the exons to ultimately encode the amino acid product.

Illustrations adapted from Nussbaum RL, McInnes RR, Willard HF, eds: *Thompson & Thompson Genetics in Medicine*, 6 ed. The human genome: structure and function of genes and chromosomes, Fig 3-6, p 20. Copyright 2001, with permission from Elsevier.

Revised: 4-22-16

Related terms: coding region; exon; intronic; splicing

Instructions

Learn More (karyotype).

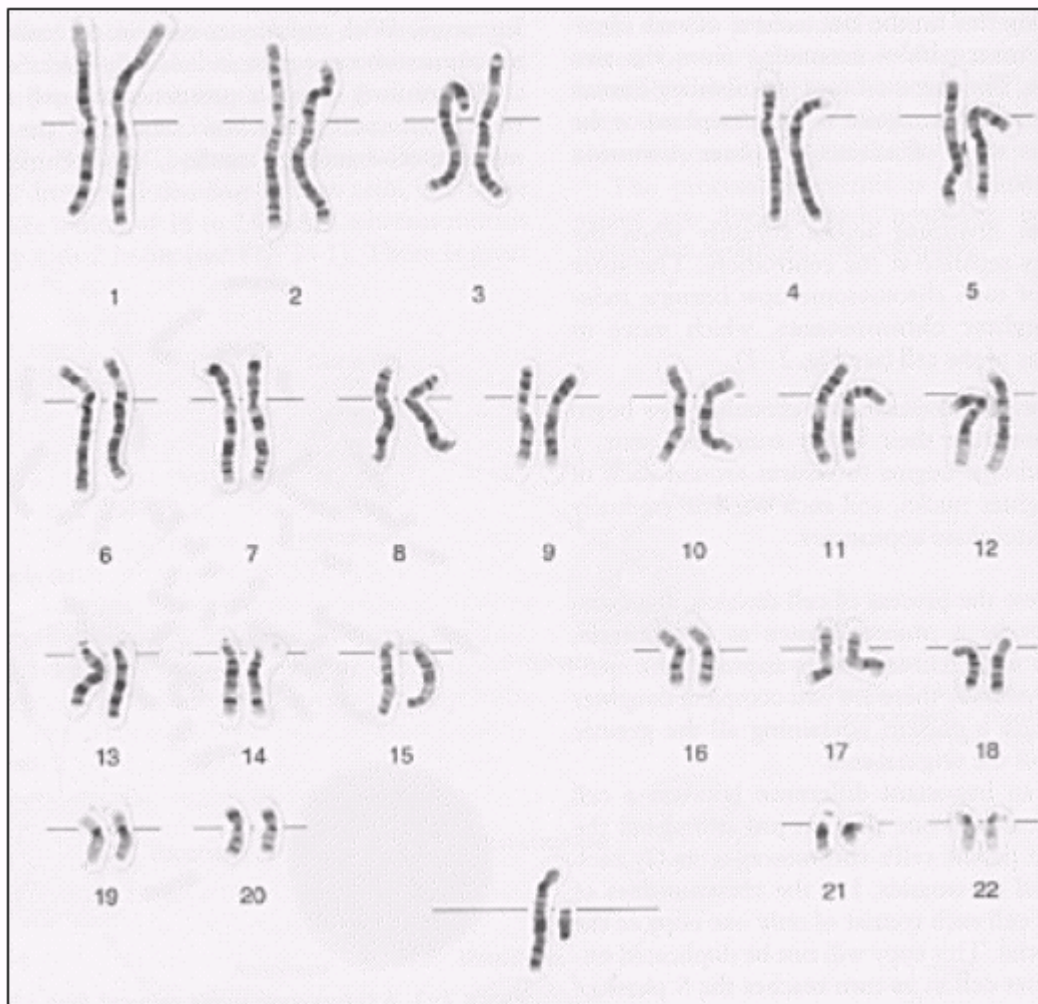
Example of a normal male karyotype, denoted 46,XY

- 46 refers to the total number of chromosomes.
- XY indicates a male karyotype; XX would indicate a female karyotype.

A normal human karyotype consists of 22 pairs of autosomes and two sex chromosomes. Note the similar size and striped (banding) pattern between each of the pairs. The autosomal chromosome pairs are numbered and arranged from largest to smallest. Bending and curling of the chromosomes are typically observed and do not represent an abnormality.

continues on next page...

continued from previous page.



Reprinted from Nussbaum RL, McInnes RR, Willard HF, eds: *Thompson & Thompson Genetics in Medicine*, 6 ed. Chromosomal basis of heredity, p 8. Copyright 2001, with permission from Elsevier.

Posted: 12-31-03

Instructions

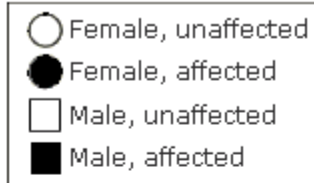
Learn More (mitochondrial inheritance).

Pedigree illustrating maternal inheritance of a [mitochondrial disorder](#)

continues on next page...

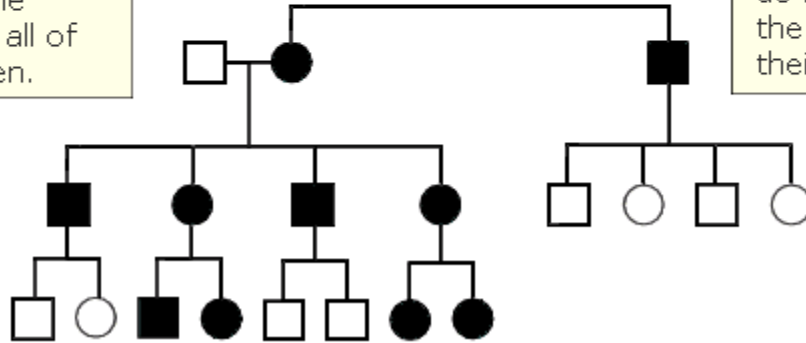
continued from previous page.

Key



Affected females transmit the disease to all of their children.

Affected males do not transmit the disease to their children.



Posted: 10-1-02

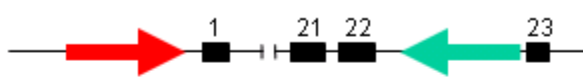
Related terms: heteroplasmy; homoplasmy; mode of inheritance; variable expressivity

Instructions

Disease Example (nonallelic homologous recombination).

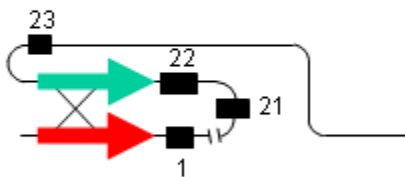
Hemophilia A is a coagulation disorder caused by mutation of the X chromosome gene *F8*, which codes for clotting factor VIII. Affected males have excessive bleeding of varying severity. Almost half of all severe hemophilia A results from an inversion mutation of exons 1-22 in *F8*, the underlying mechanism for which is abnormal pairing and recombination between two similar DNA sequences occurring in tandem.

Normal sequence of *F8*



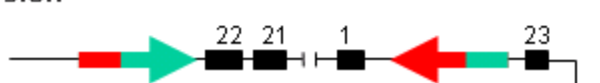
Red and green arrows represent homologous sequences located 500 kb apart on the same DNA strand. ■ = exons

Abnormal pairing and recombination



Crossing over occurs between the homologous segments (red and green arrows) on the same chromosome.

Inversion

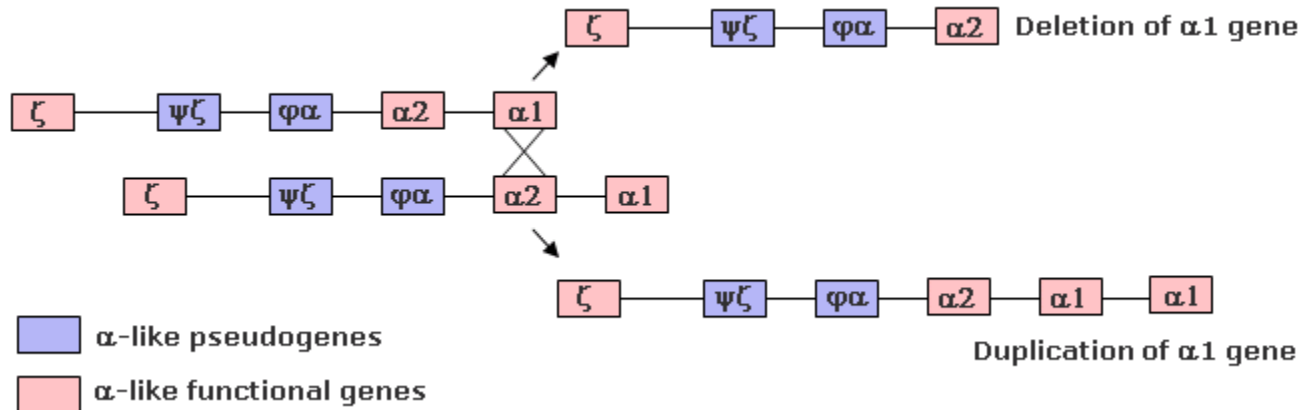


Exons 1 through 22 are now in reverse order within the gene.

continues on next page...

continued from previous page.

Alpha thalassemia. The alpha globin genes on chromosome 16 are part of a highly homologous gene "family." The alpha globin cluster consists of five alpha-like genes, three functional and two pseudogenes, aligned head to tail along the chromosome. Because of the remarkable similarity between the genes, pseudogenes, and intron sequences in this cluster, homologous genes on chromosomes 16 can occasionally misalign at meiosis. This misalignment predisposes to unequal crossing over, thereby producing deletions and duplications.



Illustrations adapted from Nussbaum RL, McInnes RR, Willard HF, eds: *Thompson & Thompson Genetics in Medicine*, 6 ed. Genetic variation in individuals: mutation and polymorphism, Fig 6-2B (p 84) and Fig 3-7 (p 21). Copyright 2001, with permission from Elsevier.

A Clinical Implication.

Nonallelic homologous recombination between segmental duplications/low copy repeats on homologous chromosomes can lead to deletions and duplications associated with different phenotypes (e.g., *PMP22* duplication [CMTA1] and *PMP22* deletion [HNPP]).

Revised: 11-16-16

Related terms: deletion; duplication; gene conversion; recombination; unequal crossing over

Instructions

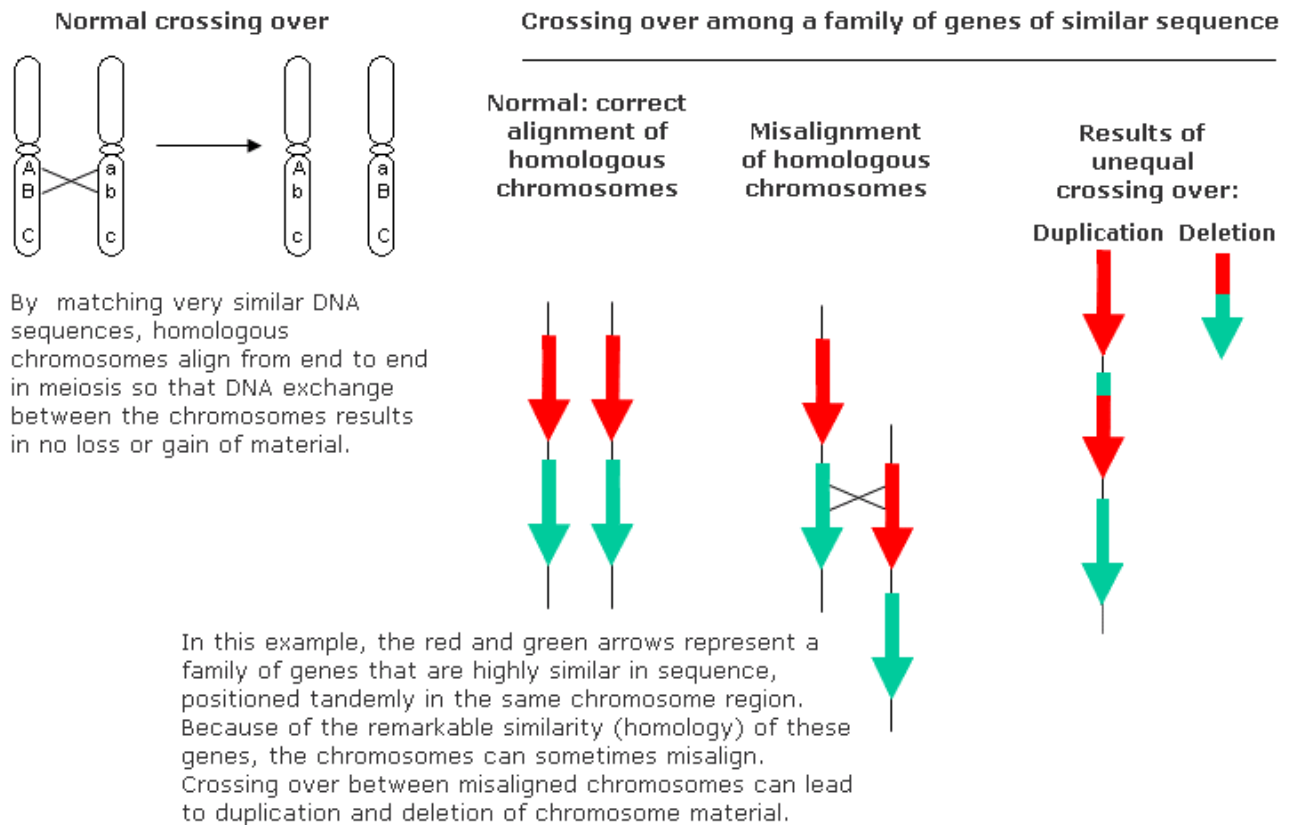
Learn More (nonallelic homologous recombination).

Illustration adapted from Nussbaum RL, McInnes RR, Willard HF, eds: *Thompson & Thompson Genetics in Medicine*, 6 ed. Genetic variation in individuals: mutation and polymorphism, Fig 6-2A, p 84. Copyright 2001, with permission from Elsevier.

Situations more susceptible to unequal crossing over

- Members of multigene "families" in which genes share significant homology with one another (e.g., alpha globin gene cluster; red and green visual pigment gene cluster)
- A gene and pseudogene in tandem on a chromosome (e.g., *CYP21* and its pseudogene *CYP21P*, *GAB* and its pseudogene *GABP*)
- Similar sequences along the same strand of DNA predisposing to inversions or deletions (e.g., *F8* inversion; contiguous gene deletions, such as 22q11.2 deletion)
- Homologous noncoding sequences (e.g., Alu family of repeated DNA sequences interspersed throughout the genome)

Revised: 11-16-16

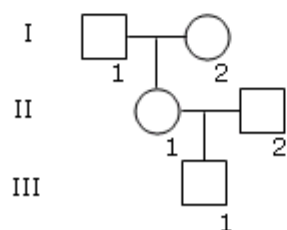
Related terms: deletion; duplication; gene conversion; recombination

Instructions

Learn More (pedigree).

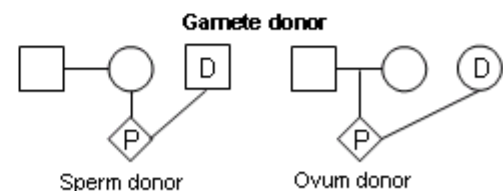
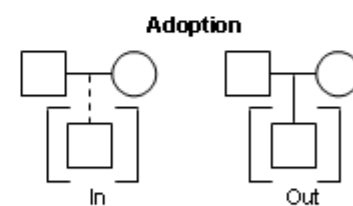
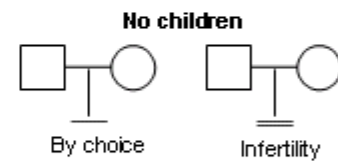
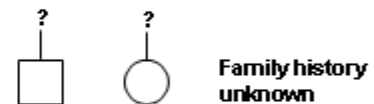
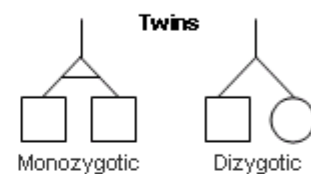
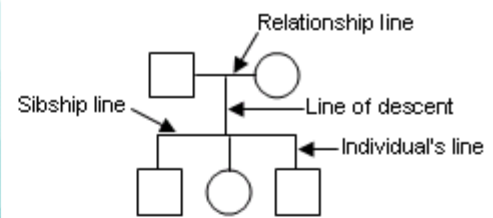
Common pedigree symbols

	Male	Female	Sex Unknown
Individual			
Affected individual			
Multiple individuals			
Multiple individuals, number unknown			
Deceased individual			
Pregnancy			
Proband			
Consultand			
Spontaneous abortion			
Termination of pregnancy			
Obligate heterozygote			
Ectopic pregnancy			



Roman numerals indicate generations; Arabic numerals indicate specific individuals within a certain generation (i.e., individual I-2 is the maternal grandmother of individual III-1).

Relationships



continued from previous page.

Symbols adapted from Bennett RL, French KS, Resta RG, Doyle DL. Standardized human pedigree nomenclature: update and assessment of the recommendations of the National Society of Genetic Counselors. *J Genet Couns.* 2008;424-33.

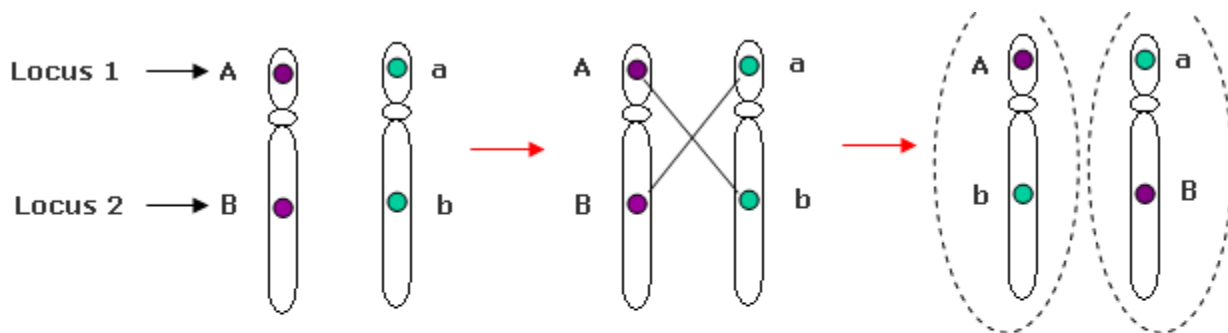
Revised: 10-2-16

Related terms: consanguineous; obligate heterozygote; proband

Instructions

Learn More (recombination).

- Two genes located on the same chromosome may or may not segregate together. Recombination between homologous chromosomes during meiosis leads to novel combinations of genes in the gamete, and hence offspring.
- Through the process of recombination, each chromosome that is transmitted from parent to child contains some segments derived from the child's grandfather and some from the child's grandmother.
- Recombination plays an important role in assuring genetic variability between individuals, even within the same family.



Homologous chromosomes pair at meiosis. Alleles **A** and **B** (and **a** and **b**) represent segments of DNA at two separate loci (1 and 2) on the same chromosomes, respectively.

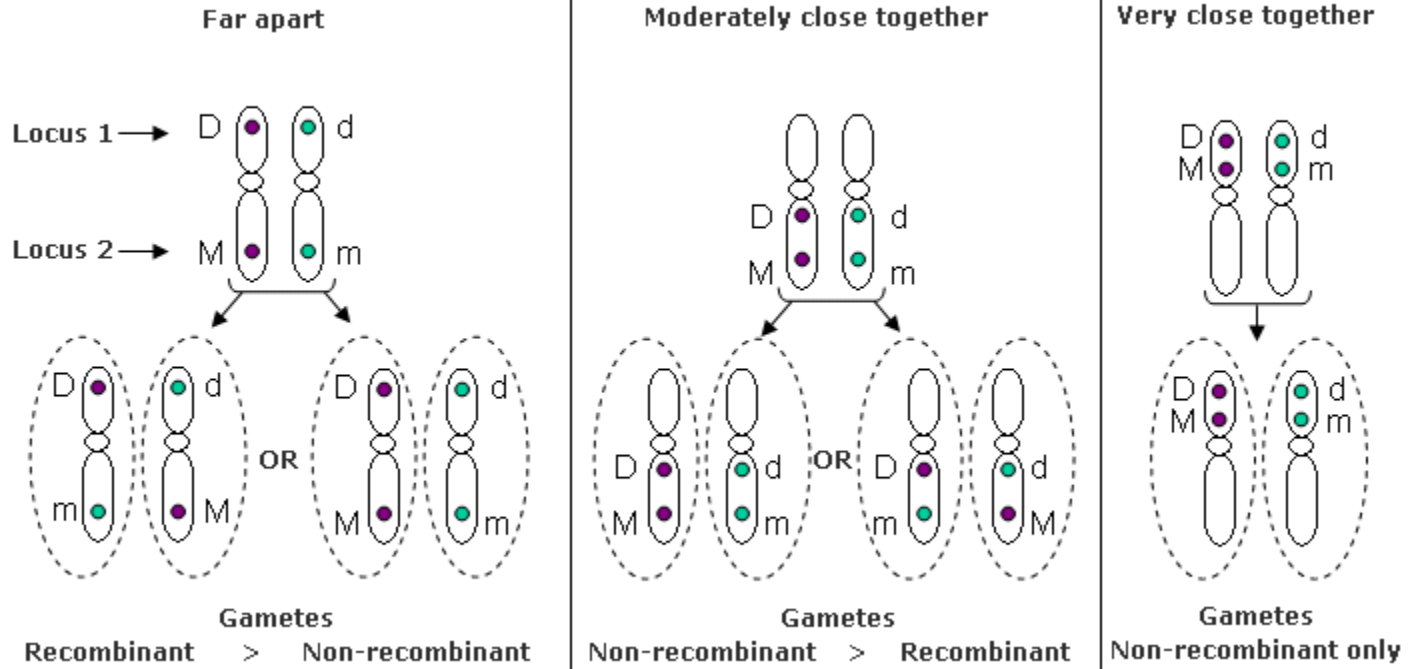
Recombination between locus 1 and locus 2 in meiosis

Gametes. One gamete contains the chromosome with **A** and **b**; the other gamete contains the chromosome with **a** and **B**. Both chromosomes are distinct from the original parental chromosomes.

The behavior during meiosis of alleles at two loci (1 and 2) on the same chromosome depends on their proximity.

continues on next page...

continued from previous page.



Illustrations adapted from Nussbaum RL, McInnes RR, Willard HF, eds: *Thompson & Thompson Genetics in Medicine*, 6 ed. Gene mapping and the human genome project, Fig 8-12, p 120. Copyright 2001, with permission from Elsevier.

Posted: 12-30-03

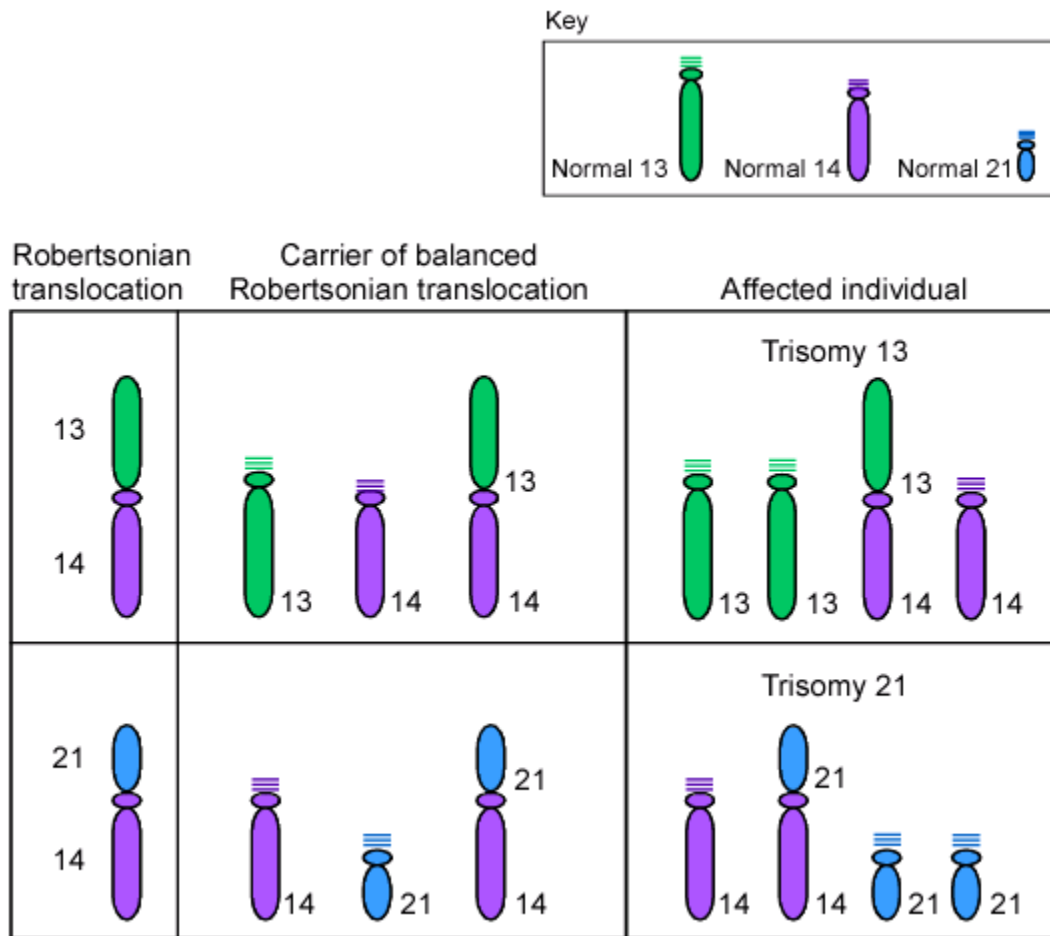
[Instructions](#)

Learn More (Robertsonian translocation).

Common **Robertsonian translocations**

continues on next page...

continued from previous page.



Revised: 2-26-04

Related terms: chromosome; deletion; duplication

Instructions

Learn More (sporadic).

Sporadic disorders may have a genetic or non-genetic etiology.

- Genetic etiology of sporadic disorders
 - Uniparental disomy - The affected individual has both chromosomes of one pair from one parent and none from the other, a chance occurrence of a genetic abnormality not likely to recur in other family members.
 - Sporadic tumors - All cancer is genetic at the cellular level; however, all cancer is NOT hereditary. A single tumor occurring in an older individual is likely to be caused by acquired (not inherited) pathogenic variants in cell regulator genes leading to uncontrolled cell proliferation.
- Non-genetic etiology of sporadic disorders
 - Congenital rubella syndrome in an infant due to maternal rubella infection during pregnancy
 - Ataxia caused by alcoholism

continues on next page...

continued from previous page.

"Sporadic" is sometimes incorrectly used to refer to the following:

Autosomal dominant or X-linked disorders that occur in a single individual in a family, often the result of a new pathogenic variant. Because recurrence risk is increased for sibs of the affected individual and is as high as 50% for the offspring of the affected individual, the use of the term "sporadic" is not appropriate. Use of the term "simplex case" is correct.

Some Clinical Implications.

- If a particular condition is truly sporadic, recurrence risk should be the same in families with an affected individual as compared to families with no history of the condition.
- Care must be taken to distinguish a true sporadic case from a simplex case (single occurrence of a condition in a family) with recurrence risk implications.
- A sporadic case is usually simplex (a single case of a disorder in a family); a simplex case may or may not be sporadic.
- The following are examples by mode of inheritance of simplex cases that are NOT sporadic. All have recurrence risk implications for subsequent offspring of the parents and of the affected individual.
 - **Autosomal recessive.** A couple with no family history of cystic fibrosis gives birth to a child with cystic fibrosis.
 - **Autosomal dominant**
 - A couple of normal stature has a child with achondroplasia.
 - A woman mildly affected by myotonic dystrophy type 1 is unaware of the diagnosis until she gives birth to a child with severe congenital myotonic dystrophy.
 - **X-linked.** A healthy woman with no family history of hemophilia A has a son with hemophilia A.
 - **Multifactorial inheritance.** A healthy couple has a child with a congenital heart defect.
 - **Chromosome abnormality.** A healthy couple has a child with Down syndrome (trisomy 21).

Updated: 4-27-16

Related terms: recurrence risk; simplex

Instructions

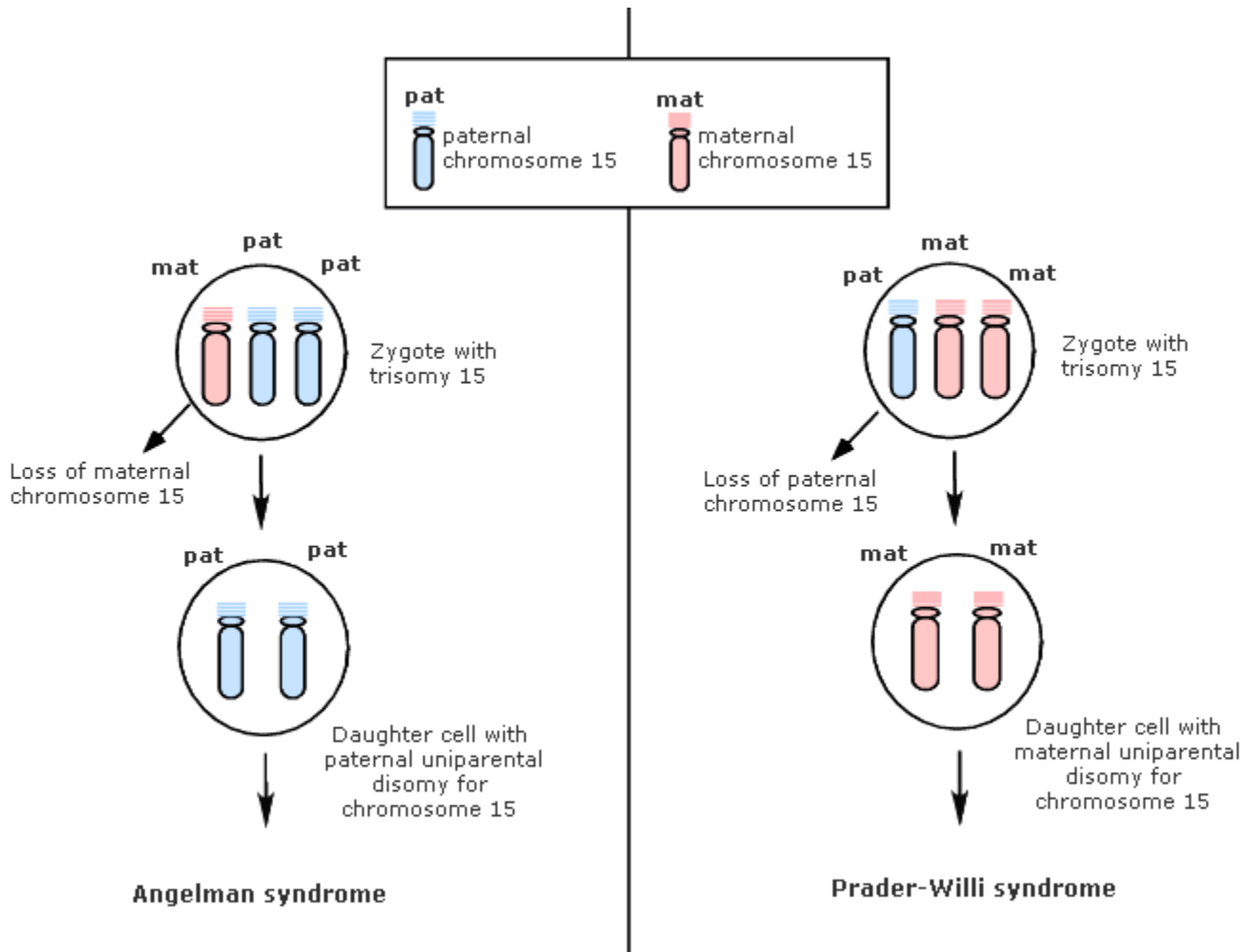
Disease Example (trisomy rescue).

Angelman syndrome can be caused by paternal uniparental disomy of chromosome 15 resulting from **trisomy rescue** of a trisomy 15 zygote (either 47,XY+15 or 47,XX+15) in which the total number of chromosomes in the cell is reduced to 46,XX or 46,XY such that two **paternal** chromosomes 15 remain.

Prader-Willi syndrome can be caused by maternal uniparental disomy of chromosome 15 resulting from **trisomy rescue** of a trisomy 15 zygote (either 47,XY+15 or 47,XX+15) in which the total number of chromosomes in the cell is reduced to 46,XX or 46,XY such that two **maternal** chromosomes 15 remain.

continues on next page...

continued from previous page.



Some Clinical Implications.

- Uniparental disomy (UPD) leads to an abnormal phenotype if the chromosome involved has imprinted gene(s) or if UPD results in homozygosity for a pathogenic variant resulting in an autosomal recessive condition.
- If prenatal diagnostic testing via chorionic villus sampling (CVS) reveals a trisomic cell line involving a chromosome known to have imprinted genes, and follow-up amniocentesis reveals normal fetal chromosomes, UPD testing for the trisomic chromosome should be considered to exclude the possibility that trisomy rescue restored the normal karyotype in the fetal cells, but in doing so, led to UPD.

Last revision: 10-31-16

Related terms: aneuploidy; imprinting; postzygotic; uniparental disomy

Instructions

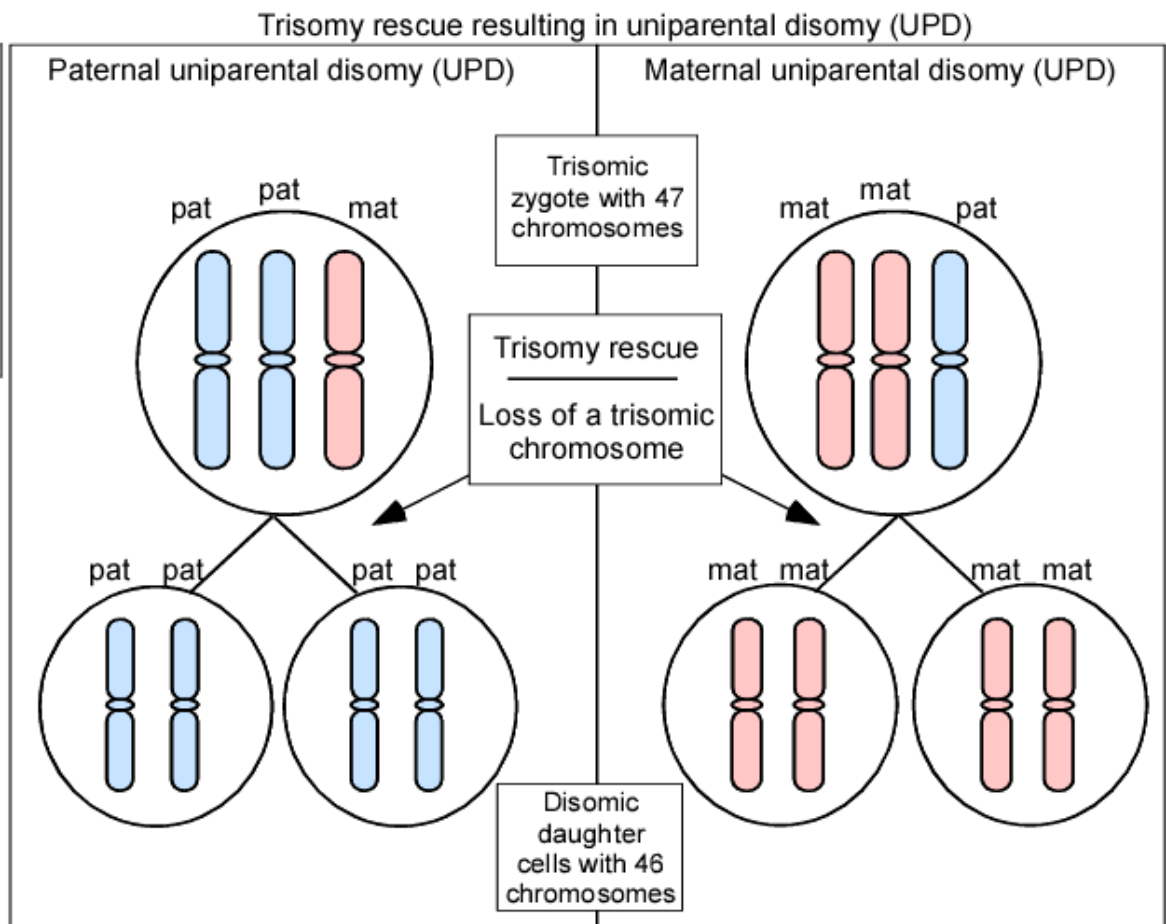
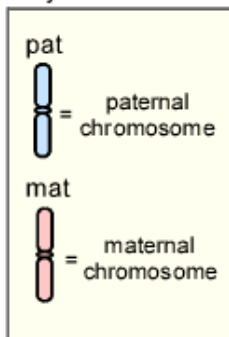
Learn More (trisomy rescue).

A trisomic conceptus consisting of a total of 47 chromosomes is usually non-viable; the trisomic chromosomes can be 2 maternal / 1 paternal or 1 maternal / 2 paternal. The outcomes of trisomy rescue (see Table) may be normal or abnormal.

Outcomes of Trisomy Rescue		
Chromosomes	Maternal/Paternal Contribution	Phenotype
46	1 mat / 1 pat (disomy)	Normal
46	2 mat / OR 2 pat (uniparental disomy)	Possibly abnormal ¹

1. The phenotype is abnormal if the chromosome involved has imprinted gene(s).

Key



Last revision: 5-7-03

Related terms: aneuploidy; imprinting; postzygotic; uniparental disomy

Instructions

Learn More (uniparental disomy).

Syndromes associated with uniparental disomy (UPD)

continues on next page...

continued from previous page.

- [Prader-Willi syndrome](#) (maternal UPD15)
- [Angelman syndrome](#) (paternal UPD15)
- [Transient neonatal diabetes mellitus](#) (paternal UPD6)
- [Russell-Silver syndrome](#) (maternal UPD7)
- [Beckwith-Wiedeman syndrome](#) (paternal UPD11)
- [MUPD14 syndrome](#) (maternal UPD14)

Revised: 4-27-16

Related terms: imprinting; trisomy rescue

Instructions

License

GeneReviews® chapters are owned by the University of Washington. Permission is hereby granted to reproduce, distribute, and translate copies of content materials for noncommercial research purposes only, provided that (i) credit for source (<http://www.genereviews.org/>) and copyright (© 1993-2024 University of Washington) are included with each copy; (ii) a link to the original material is provided whenever the material is published elsewhere on the Web; and (iii) reproducers, distributors, and/or translators comply with the [GeneReviews® Copyright Notice and Usage Disclaimer](#). No further modifications are allowed. For clarity, excerpts of GeneReviews chapters for use in lab reports and clinic notes are a permitted use.

For more information, see the [GeneReviews® Copyright Notice and Usage Disclaimer](#).

For questions regarding permissions or whether a specified use is allowed, contact: admasst@uw.edu.